

EFFECTIVE FROM
01.03.2023



The Kitchen Essentials

**INTELLIGENT
DESIGN IDEAS
THAT LASTS
FOREVER**



www.jaynasinks.com

Kitchen Sinks • Floor Drains • Shower Channels • Faucets

Make in India



Headquartered in New Delhi, India the company takes great pride in its ability to deliver a magnificent product range with elegant designs and versatile functionalities.



Our History & Product Quality

Tap Mixer Hole

The well placed Tap Mixer Hole (in select models of sinks can be provided on demand)

Plumbing Connectors

FREE Plumbing Connectors are provided along with select models / sizes of JAYNA sinks for effective single water outlet for both the bowls. Exclusive plumbing connector is provided with sink model SBMB-08 and SBMB-09.

Installation Type

JAYNA sinks are available in three different installation types:

1) Sit-on (SO)



2) Flat (FB)



3) In-set (FBC)



In-set (FBC) with clamp In-set type sink will cost ₹ 400/- extra

JAYNA - A Perfect Lifestyle Statement

Jain Brothers Sanitation Pvt. Ltd. is one of the renowned makers of Stainless Steel Sinks in India. Since 1992, it has continuously redefined the market with products that bear the distinct hallmarks of superior quality, thoughtful functionality and above all, world-class design. JAYNA pioneered the use of premium quality stainless steel for kitchen sinks in the country and has time & again introduced products that set benchmarks. In fact, the credit for Jayna's huge success in the Indian market goes to the indomitable spirit that constantly strives to win customers' hearts through products that offer more in terms of form, function and value.



Always look for

JAYNA

authentic hologram on each sink



Our Infrastructure

At Jayna, we have state of the art production facilities which not only promises high quality standards but provide prompt and timely deliveries as well. The Infrastructure has been planned with minutest details to adhere to the benchmarks and provide a consistent product.

Today as world sprints ahead, there is growth in multiple sectors each requiring infrastructure development to sustain the growth. This holds true for the housing sector as well. JBSPL is committed to play a significant role in this regard.

The company has developed a variety of products so as to cater to different needs of its consumers. JBSPL leads the way with products that are trendsetters and lifestyle definers in the ever changing social-economic scenario by introducing ranges such as Noble, Regal, Magnum, King etc.

OUR VISION
IS TO DELIVER
BEST PRODUCT
SOLUTIONS



Unique features

of JAYNA

Stainless Steel

Kitchen Sinks:

Material

JAYNA Kitchen Sinks are made from 100% non-magnetic, corrosion-free high-grade stainless steel conforming to AISI-304 (18/8) grade.

Sizes & Design

JAYNA has one of the most extensive ranges of premium quality sinks available in 145 models/designs in over 215 different sizes to choose from.

Certifications

The Company has been authorized by the Bureau of Indian Standards (BIS) to use quality mark ISI (CML No. 9200115705) on a select range of sinks.

Plastic Coating

JAYNA sinks are provided with a special plastic coating which protects the sink from scratches and wear & tear, during installation.

Coupling

JAYNA sinks have specially designed 4" coupling/strainer made from high-grade stainless steel.

Undercoating

JAYNA sinks come with undercoating (on demand) which absorbs sound and protects against condensation.

Sound Deadening PAD (SDP)

The special Sound Deadening Pads (rubber pads) are glued under the sinks to reduce noise.

Finishes

JAYNA sinks are available in six different finishes:

1. Glossy finish
2. Matt finish
3. Brush finish (Square Sink range)
4. Satin Finish
5. Anti-Scratch (Linen Finish)



The Kitchen Essentials

“

WE ARE
COMMITTED
TO MAINTAIN
OUR QUALITY

AISI 304
18/8 STEEL

RUST
PROOF

LIFETIME
WARRANTY

GLOSS - MATT
FINISHES
ANTI-SCRATCH

100%
Non-Magnetic

145x215
Models Sizes



INDEX



| | |
|---|---------|
| Quartz Collection Elleci | 6 – 7 |
| Mixer Collection | 8 – 9 |
| Quartz Collection Jio | 10 – 13 |
| Signature Collection | 14 – 25 |
| Spartan/Oracle | 14 – 15 |
| Galaxy | 16 – 17 |
| Jupiter | 18 – 19 |
| Apollo | 20 |
| Mercury/Mars/Venus | 21 |
| Zodiac I Symphony | 22 |
| Jubilee | 23 |
| Crown/Atlas | 24 |
| Pluto/Neptune | 25 |
| Sanitary Essentials | 26 – 27 |
| Accessories | 28 |
| Pelican Wash Basins | 29 – 31 |
| Collection International | 32 – 63 |
| Combo Series | 32 – 35 |
| PVD Collection (NEW) | 36 – 37 |
| Regal PVD Collection (NEW) | 38 – 39 |
| Noble Square Series | 40 – 43 |
| Regal Series | 44 – 45 |
| Square Series | 46 – 49 |
| Square R-10 Series | 50 – 51 |
| Designo Series | 52 – 54 |
| Aura Series | 55 |
| Accessories | 56 – 57 |
| Chrome/304 Stainless Steel Faucets | 58 – 59 |
| Kitchen Faucets Single Lever-Chrome Finish | 60 – 63 |
| Smart Series Linear Shower Channel | 64 – 71 |
| Smart Series Floor Drain | 72 – 73 |
| PVD Shower Channels | 74 – 75 |
| Shower Channel | 76 – 81 |
| Floor Drain | 82 – 91 |
| King/Regular/Classic/ Flora / Neon | 82 – 84 |
| Elegant Premium/Aspire/ Magic | 85 |
| Garnet Lotus/Wonder | 86 |
| Rain Roof Drainer/ Clean Out Heavy/ Clean Out Big | 87 |
| Gratings | 88 – 91 |
| Manhole Cover | 92 – 93 |
| Hydro/ Rain Water Drainage Cover | 94 |
| Access Cover/Box Channel/ PVC Accessories | 95 |
| Bath Accessories | 96 – 99 |
| Rack Bolt/Brass Bottle Trap/Bottle Trap Pipe/ Teflon Tape | 96 |
| Waste Coupling Pop-up/ Waste Coupling Long Thread/ Waste Coupling Dome Thread | 97 |
| Hoses/ Extension Nipples | 98 |
| Health Faucets/ Jet Spray/ Flanges | 99 |



Scan to
Download
the Catalogue

QUARTZ COLLECTION



100%
Made in
ITALY

Quartz Collection



Composite Granite Sinks are the best products for design, resistance and colour matching



Impact Resistance



UV Protection



Anti-Bacterial Protection



Thermic Shock Resistance



Aluminium



Ghisa

Colours Available

Quadra 110



| | |
|------------------------|--|
| CAT. MODEL | QUADRA 110 Single Bowl Kitchen Sink |
| Overall Size (Inch/mm) | 24 x 20 x 8.5 610 x 500 x 220 |
| Material | Metaltek |
| Colors | Aluminium & Ghisa |
| MRP Aluminium | ₹ 23,245/- |
| MRP Ghisa | ₹ 22,045/- |



When it starts the composition

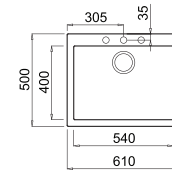

Built-in hole
590 x 480 mm



Quadra 130



| | |
|------------------------|--|
| CAT. MODEL | QUADRA 130 Single Bowl Kitchen Sink |
| Overall Size (Inch/mm) | 31 x 20 x 8.5 790 x 500 x 220 |
| Material | Metaltek |
| Colors | Aluminium |
| MRP Aluminium | ₹ 30,210/- |

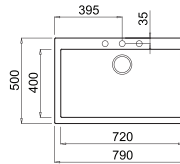

Built-in hole
770 x 480 mm



Best 500



| | |
|------------------------|---|
| CAT. MODEL | BEST 500 Double Bowl with Single Drain Board |
| Overall Size (Inch/mm) | 45.5 x 20 x 08 1160 x 510 x 200 |
| Material | Metaltek |
| Colors | Aluminium & Ghisa |
| MRP Aluminium | ₹ 47,695/- |
| MRP Ghisa | ₹ 46,495/- |

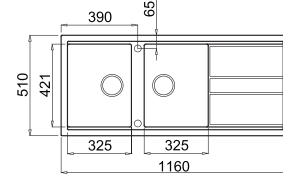

Built-in hole
1140 x 480



Best 480



| | |
|------------------------|---|
| CAT. MODEL | BEST 480 Single Bowl Kitchen Sink with Drain Board |
| Overall Size (Inch/mm) | 39.5 x 20 x 08 1000 x 510 x 200 |
| Material | Metaltek |
| Colors | Aluminium & Ghisa |
| MRP Aluminium | ₹ 37,185/- |
| MRP Ghisa | ₹ 35,985/- |

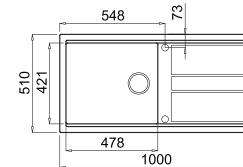

Built-in hole
980 x 480 mm



Best 475



| | |
|------------------------|--|
| CAT. MODEL | BEST 475 Kitchen Sink with Vegetable Bowl / Drain Board |
| Overall Size (Inch/mm) | 39.5 x 20 x 08 1000 x 510 x 200 |
| Material | Metaltek |
| Colors | Aluminium & Ghisa |
| MRP Aluminium | ₹ 45,370/- |
| MRP Ghisa | ₹ 44,160/- |

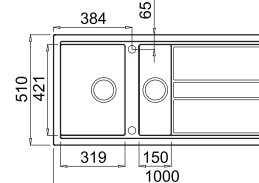

Built-in hole
980 x 480 mm



Best 450



| | |
|------------------------|--------------------------------------|
| CAT. MODEL | BEST 450 Double Bowl Kitchen Sink |
| Overall Size (Inch/mm) | 32 x 20 x 08 860 x 510 x 200 |
| Material | Metaltek |
| Colors | Aluminium & Ghisa |
| MRP Aluminium | ₹ 40,720/- |
| MRP Ghisa | ₹ 39,520/- |

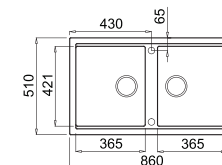

Built-in hole
840 x 480 mm



MIXER COLLECTION

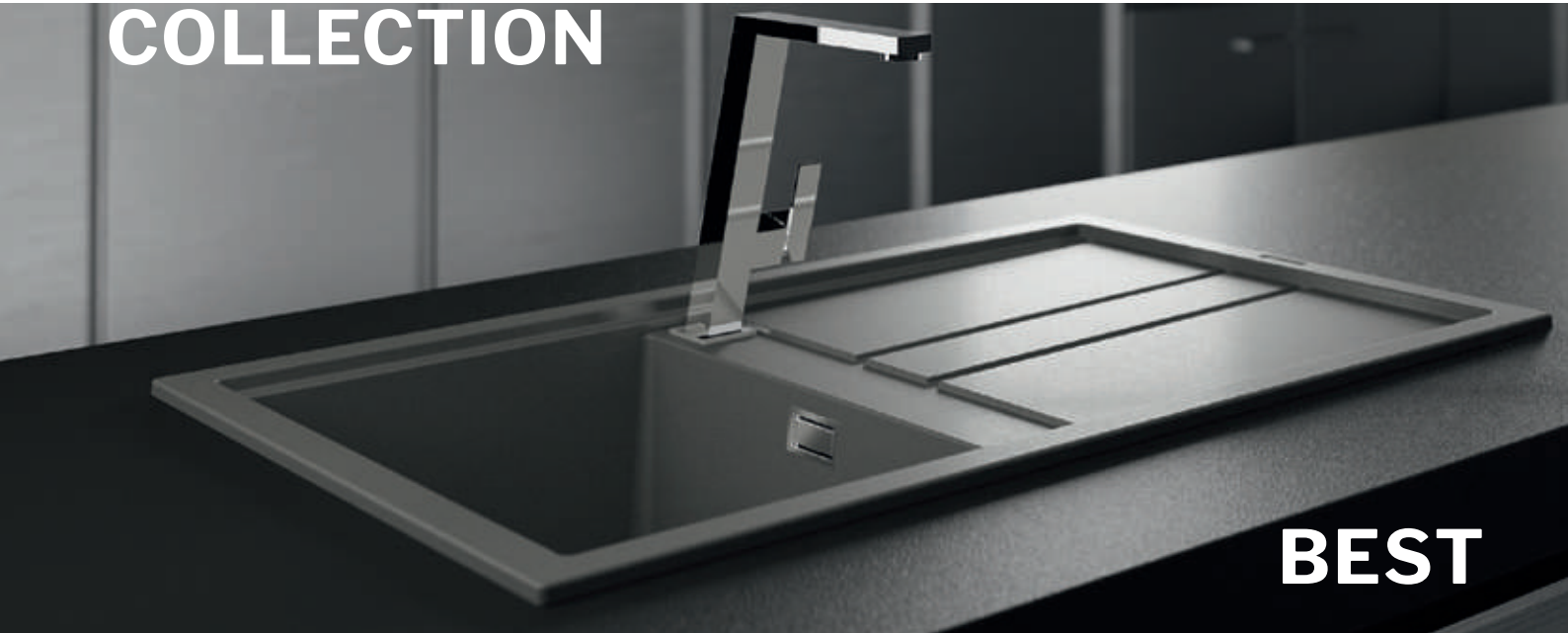

BEST



Blade Mixer

Lever mixer with inclined swivel spout.

Mixer hole dimensions: \varnothing 35 mm

| Cat. Model | Finish | MRP (₹) |
|------------|-----------|----------|
| Blade A | Aluminium | 60,960/- |
| Blade B | Chrome | 57,905/- |

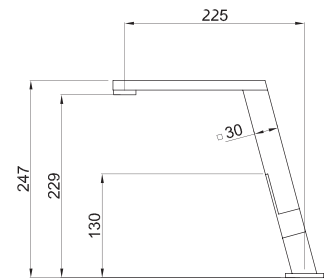

Bridge Mixer

Lever mixer with swivel spout.

Mixer hole dimensions: \varnothing 35 mm

| Cat. Model | Finish | MRP (₹) |
|------------|--------|----------|
| Bridge B | Chrome | 30,045/- |

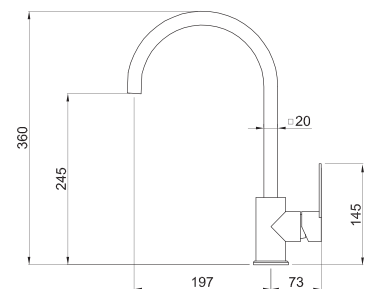

Dove Plus

Lever mixer with high swivel spout and pull-out shower

Mixer hole dimensions: \varnothing 35 mm

| Cat. Model | Finish | MRP (₹) |
|-------------|-----------|----------|
| Dove Plus A | Aluminium | 59,540/- |
| Dove Plus B | Chrome | 57,355/- |

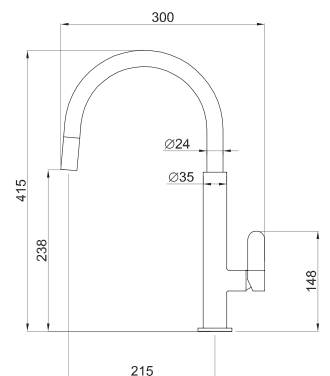



Colander 01

Cat Model: AVI03001
Size: 322 x 194 x 95 mm
MRP: ₹ 11,525/-



Colander 02

Cat Model: AVI03000
Size: 444 x 142 x 103 mm
MRP: ₹ 11,525/-



Basket 01

Cat Model: ACI01306
Size: 444 x 292 x 82 mm
MRP: ₹ 9,340/-



Basket 02

Cat Model: ACI01301
Size: 299 x 384 x 175 mm
MRP: ₹ 8,245/-



Glass Chopping Board

Cat Model: ATV01002
MRP: ₹ 13,490/-

For all our Granite kitchen sinks we provided a series of accessories which enrich the aesthetics and functionality of our sinks and optimize all your movements in the kitchen.

COLOURS AND MATERIALS

The chemical composition is made up of natural granite, acrylic resin and, like all the sinks manufactured with the technological leadership G.P.S. system, has an even mass resulting in high resistance to stains, impact and temperature changes. The uniqueness of this product is that have been added the metal particles, making the product with a brilliant and shining finish. The target is

to obtain special "metallic effects". The different finishes allow a perfect match between the sink and the other stainless steel components in the kitchen.



Aluminium



Ghisa



Impact Resistance



UV Protection



Anti-Bacterial Protection



Thermic Shock Resistance



Features

Minimal Bowl Radius | Wider Sink Bowl Divider With Taphole | Bigger Bowls | Professional Drip Edge | Accessories Glide On Special Rims | Integrated Drain Cover.

Jayna Elleci sinks have a **TOTAL ANTI-BACTERIAL PROTECTION**, which has an adequate antibacterial coverage of the mass.

In this way the bacterial organisms are repelled. Reliability and practicality become a certainty every day in the kitchen.



JIO QUARTZ COLLECTION



Jio Quartz Collection

This Collection is made of Natural Quartz minerals for everyday use in modern contemporary kitchens. These sinks will compliment the kitchen with colour matching & making the kitchen aesthetically better.

Colours Available

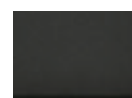

Metallic
Black



Space
Grey

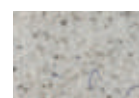

Earthy
Brown



Cemento
Grey



Mocha
Brown

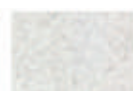

Light
Brown



Sky
White

JIO 1816

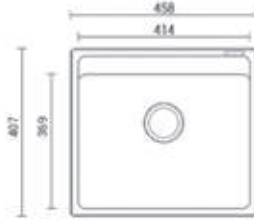

| | | | |
|------------------------|---------|--------------------------------------|---------|
| CAT. MODEL | | JIO 1816 Single Bowl Kitchen Sink | |
| Overall Size (Inch/mm) | | 18 x 16 x 08 457 x 407 x 200 | |
| Material | | Natural Quartz | |
| MRP Space Grey | 6,285/- | Light Brown | 6,285/- |
| MRP Metallic Black | 6,565/- | Sky White | 6,285/- |
| MRP Cemento Grey | 6,565/- | Mocha Brown | 6,565/- |

JIO 2118

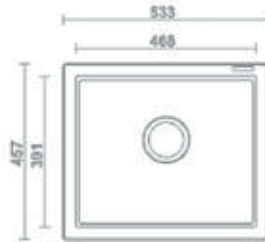

| | | | |
|------------------------|---------|--------------------------------------|---------|
| CAT. MODEL | | JIO 2118 Single Bowl Kitchen Sink | |
| Overall Size (Inch/mm) | | 21 x 18 x 08 533 x 457 x 200 | |
| Material | | Natural Quartz | |
| MRP Space Grey | 7,165/- | Light Brown | 7,165/- |
| MRP Metallic Black | 7,495/- | Sky White | 7,165/- |
| MRP Cemento Grey | 7,495/- | Mocha Brown | 7,495/- |

JIO 2220

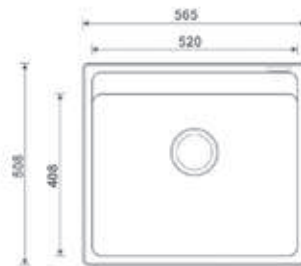

| | | | |
|------------------------|---------|--------------------------------------|---------|
| CAT. MODEL | | JIO 2220 Single Bowl Kitchen Sink | |
| Overall Size (Inch/mm) | | 22 x 20 x 08 565 x 508 x 200 | |
| Material | | Natural Quartz | |
| MRP Space Grey | 9,200/- | Light Brown | 9,200/- |
| MRP Metallic Black | 9,930/- | Sky White | 9,200/- |
| MRP Earthy Brown | 9,200/- | Mocha Brown | 9,930/- |
| MRP Cemento Grey | 9,930/- | | |

JIO 2418

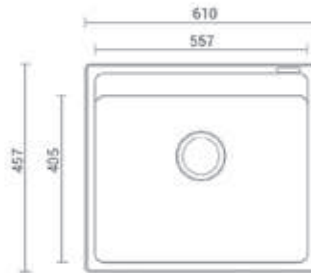

| | | | |
|------------------------|---------|--------------------------------------|---------|
| CAT. MODEL | | JIO 2418 Single Bowl Kitchen Sink | |
| Overall Size (Inch/mm) | | 24 x 18 x 08 610 x 457 x 200 | |
| Material | | Natural Quartz | |
| MRP Space Grey | 7,410/- | Light Brown | 7,410/- |
| MRP Metallic Black | 7,950/- | Sky White | 7,410/- |
| MRP Cemento Grey | 7,950/- | Mocha Brown | 7,950/- |



JIO 3120

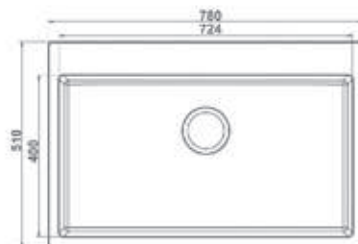

| | | | |
|------------------------|-----------|--------------------------------------|-----------|
| CAT. MODEL | | JIO 3120 Single Bowl Kitchen Sink | |
| Overall Size (Inch/mm) | | 31 x 20 x 09 780 x 510 x 225 | |
| Material | | Natural Quartz | |
| MRP Metallic Black | 14,950 /- | Light Brown | 13,900 /- |
| MRP Space Grey | 13,900 /- | Sky White | 13,900 /- |
| MRP Mocha Brown | 14,950 /- | Cemento Grey | 14,950 /- |



Jio Quartz Collection

This Collection is made of Natural Quartz minerals for everyday use in modern contemporary kitchens. These sinks will compliment the kitchen with colour matching & making the kitchen aesthetically better.

Colours Available

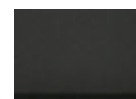

Metallic
Black



Space
Grey

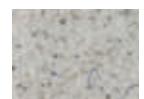

Earthy
Brown



Cemento
Grey



Mocha
Brown



Light
Brown



Sky
White

JIO 3417

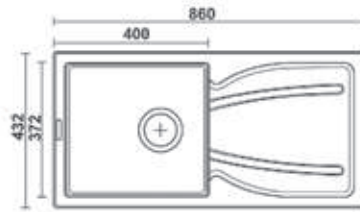

| | |
|------------------------|---|
| CAT. MODEL | JIO 3417 Single Bowl Kitchen Sink with Drain Board |
| Overall Size (Inch/mm) | 34 x 17 x 08 860 x 432 x 200 |
| Material | Natural Quartz |
| MRP Earthy Brown | 11,905/- |

JIO 3618

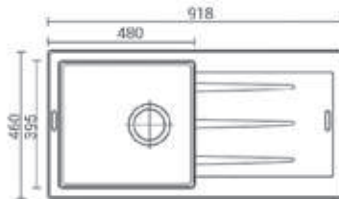

| | | | |
|------------------------|---|-------------|----------|
| CAT. MODEL | JIO 3618 Single Bowl Kitchen Sink with Drain Board | | |
| Overall Size (Inch/mm) | 36 x 18 x 09 918 x 460 x 228 | | |
| Material | Natural Quartz | | |
| MRP Space Grey | 12,460/- | Light Brown | 12,460/- |
| MRP Metallic Black | 13,010/- | Sky White | 12,460/- |
| MRP Cemento Grey | 13,010/- | Mocha Brown | 13,010/- |

JIO 3420

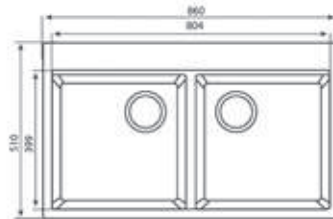

| | | | |
|------------------------|--------------------------------------|-------------|----------|
| CAT. MODEL | JIO 3420 Double Bowl Kitchen Sink | | |
| Overall Size (Inch/mm) | 34 x 20 x 09 860 x 510 x 225 | | |
| Material | Natural Quartz | | |
| MRP Space Grey | 15,500/- | Light Brown | 15,500/- |
| MRP Metallic Black | 16,700/- | Sky White | 15,500/- |
| MRP Cemento Grey | 16,700/- | Mocha Brown | 16,700/- |

JIO 4520 A

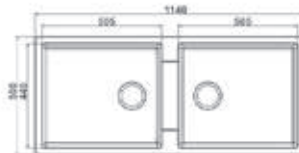

| | | | |
|------------------------|--|-------------|----------|
| CAT. MODEL | JIO 4520 A Double Bowl Kitchen Sink | | |
| Overall Size (Inch/mm) | 45 x 20 x 09 1140 x 505 x 225 | | |
| Material | Natural Quartz | | |
| MRP Space Grey | 19,295/- | Light Brown | 19,295/- |
| MRP Metallic Black | 20,950/- | Sky White | 19,295/- |
| MRP Cemento Grey | 20,950/- | Mocha Brown | 20,950/- |

JIO 4620

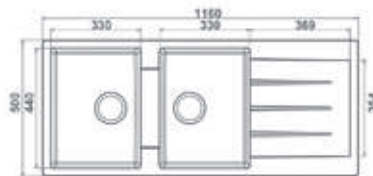

| | | | |
|------------------------|---|-------------|----------|
| CAT. MODEL | JIO 4620 Double Bowl Single Drain Kitchen Sink | | |
| Overall Size (Inch/mm) | 46 x 20 x 09 1160 x 500 x 225 | | |
| Material | Natural Quartz | | |
| MRP Space Grey | 21,750/- | Light Brown | 21,750/- |
| MRP Metallic Black | 23,500/- | Sky White | 21,750/- |
| MRP Cemento Grey | 23,500/- | Mocha Brown | 23,500/- |



AISI 304
18/8 STEEL |
 RUST
PROOF |
 LIFETIME
WARRANTY |
 GLOSS · MATT
FINISHES
ANTI-SCRATCH |
 100%
Non-Magnetic |
 145x215
Models Sizes

Featuring Sink (top):
OR 01 815 x 510 x 225 mm

ORACLE

A classic single-bowl sink with flange and wide decks for tackling tough tasks with ease. Available in shining glossy finish and satin matt, its elegance and traditional complements any home and assures greater life with very little maintenance.

Features

- 1.0 mm thickness gives durability and longevity
- Glossy, matt & anti-scratch finish
- Modern functional design
- International styling
- Advanced sound deadening technology
- Insect proof concentric coupling



Galaxy
SBF 06 (PREMIUM)
610 x 460 x 200 mm



Jupiter
SBSD 09 (PREMIUM)
1040 x 510 x 178 mm



Apollo
DBF 06 (Deluxe)
940 x 465 x 225 mm



| CAT. MODEL | DIMENSIONS | | MRP (₹) | | |
|-------------------|--------------------------|---------------------------------|---------|-------|--------------|
| | Overall Size (inch/mm) | Bowl Size (inch/mm) | Glossy | Matt | Anti-Scratch |
| SB 01 (Mini Bowl) | 12.5 x 8.5 315 x 215 | 11 x 07 x 05 270 x 170 x 125 | 3,380 | 3,500 | - |
| SB 02 | 18.5 x 16.5 470 x 420 | 17 x 15 x 08 428 x 380 x 200 | 4,590 | 4,910 | - |
| SB 02 A | 17.5 x 15.5 445 x 395 | 16 x 14 x 08 408 x 352 x 200 | 4,590 | 4,910 | - |



| CAT. MODEL | DIMENSIONS | | MRP (₹) | | |
|------------|------------------------|---------------------------------|---------|-------|--------------|
| | Overall Size (inch/mm) | Bowl Size (inch/mm) | Glossy | Matt | Anti-Scratch |
| SB 08 | 18 x 18 458 x 458 | 15 x 15 x 08 380 x 380 x 200 | 6,290 | 6,625 | - |
| SB 09 | 20 x 20 510 x 510 | 15 x 15 x 08 380 x 380 x 200 | 7,285 | 7,605 | - |



| CAT. MODEL | DIMENSIONS | | MRP (₹) | | |
|------------|--------------------------|---------------------------------|---------|-------|--------------|
| | Overall Size (inch/mm) | Bowl Size (inch/mm) | Glossy | Matt | Anti-Scratch |
| SB 03 | 19.5 x 17.5 495 x 445 | 18 x 16 x 08 460 x 400 x 200 | 5,525 | 5,855 | 8,775 |
| SB 04 | 21.5 x 17.5 545 x 445 | 20 x 16 x 08 510 x 404 x 200 | 6,680 | 7,015 | 9,905 |
| SB 05 | 25.5 x 19.5 645 x 495 | 24 x 18 x 08 600 x 450 x 200 | 8,520 | 8,840 | - |
| SB 06 | 23.5 x 18.5 595 x 470 | 22 x 17 x 08 550 x 430 x 200 | 7,395 | 7,710 | - |



| CAT. MODEL | DIMENSIONS | | MRP (₹) | | |
|------------|------------------------|---|---------|-------|--------------|
| | Overall Size (inch/mm) | Bowl Size (inch/mm) | Glossy | Matt | Anti-Scratch |
| SB R01 | 454 mm | ROUND SINK BOWL 398 MM DEPTH 180 MM | 6,410 | 6,735 | - |



| CAT. MODEL | DIMENSIONS | | MRP (₹) | | |
|------------|------------------------|---------------------------------|---------|--------|--------------|
| | Overall Size (inch/mm) | Bowl Size (inch/mm) | Glossy | Matt | Anti-Scratch |
| SB 07 | 21 x 21 535 x 535 | 20 x 20 x 10 510 x 510 x 250 | 11,700 | 12,020 | - |

ORACLE (Single bowl sinks with flange)



| CAT. MODEL | DIMENSIONS | | MRP (₹) | |
|------------|------------------------|---------------------------------|---------|--------|
| | Overall Size (inch/mm) | Bowl Size (inch/mm) | Glossy | Matt |
| OR 01 | 32 x 20 815 x 510 | 29 x 17 x 09 737 x 432 x 225 | 18,715 | 19,035 |
| OR 02 | 30 x 20 760 x 510 | 27 x 17 x 09 680 x 432 x 225 | 16,100 | 16,435 |
| OR 03 | 27 x 20 685 x 510 | 24 x 17 x 09 610 x 432 x 225 | 13,900 | 14,220 |



| CAT. MODEL | DIMENSIONS | | MRP (₹) | |
|------------|------------------------|---------------------------------|---------|--------|
| | Overall Size (inch/mm) | Bowl Size (inch/mm) | Glossy | Matt |
| OR 04 | 32 x 20 815 x 510 | 29 x 17 x 09 737 x 432 x 225 | 18,715 | 19,035 |



| CAT. MODEL | DIMENSIONS | | MRP (₹) | | |
|-------------|------------------------|----------------------------------|---------|-------|--------------|
| | Overall Size (inch/mm) | Bowl Size (inch/mm) | Glossy | Matt | Anti-Scratch |
| SBFB Mini | 12 x 12 305 x 305 | 10 x 09 x 4.5 255 x 230 x 115 | 3,430 | 3,540 | - |
| SBFB Super | 16 x 14 408 x 356 | 14 x 12 x 08 356 x 304 x 200 | 4,590 | 4,910 | - |
| SBFB Medium | 17 x 17 430 x 430 | 15 x 14 x 07 380 x 355 x 178 | 4,590 | 4,910 | - |
| SBFB Big | 18 x 18 458 x 458 | 16 x 16 x 08 408 x 408 x 200 | 6,655 | 6,975 | - |
| SBFB Large | 19 x 19 480 x 480 | 16 x 16 x 08 408 x 408 x 200 | 6,815 | 7,140 | - |



| CAT. MODEL | DIMENSIONS | | MRP (₹) | | |
|------------|--------------------------|---------------------------------|---------|-------|--------------|
| | Overall Size (inch/mm) | Bowl Size (inch/mm) | Glossy | Matt | Anti-Scratch |
| SBFB 01 | 19 x 16 480 x 408 | 16 x 14 x 08 408 x 352 x 200 | 4,590 | 4,910 | 7,700 |
| SBFB 01A | 19.5 x 16.5 495 x 420 | 16 x 14 x 08 408 x 352 x 200 | 4,725 | 5,045 | - |
| SBFB 02 | 20 x 17 510 x 430 | 17 x 15 x 08 428 x 380 x 200 | 5,065 | 5,390 | 8,440 |



| CAT. MODEL | DIMENSIONS | | MRP (₹) | | |
|------------|------------------------|---------------------------------|---------|-------|--------------|
| | Overall Size (inch/mm) | Bowl Size (inch/mm) | Glossy | Matt | Anti-Scratch |
| SBFB 03 | 21 x 18 535 x 460 | 18 x 16 x 08 460 x 400 x 200 | 5,835 | 6,155 | 8,855 |



| CAT. MODEL | DIMENSIONS | | MRP (₹) | | |
|------------|------------------------|---------------------------------|---------|-------|--------------|
| | Overall Size (inch/mm) | Bowl Size (inch/mm) | Glossy | Matt | Anti-Scratch |
| SBFB 04 | 22 x 18 560 x 460 | 20 x 16 x 08 510 x 404 x 200 | 6,270 | 6,590 | 9,400 |



| CAT. MODEL | DIMENSIONS | | MRP (₹) | | |
|------------|--------------------------|---------------------------------|---------|-------|--------------|
| | Overall Size (inch/mm) | Bowl Size (inch/mm) | Glossy | Matt | Anti-Scratch |
| SBF 01 | 18 x 16 460 x 405 | 16 x 14 x 08 410 x 352 x 200 | 4,590 | 4,910 | - |
| SBF 02 | 18.5 x 16.5 470 x 420 | 17 x 15 x 08 428 x 378 x 200 | 4,590 | 4,910 | - |
| SBF 03 | 15 x 12 380 x 305 | 13 x 10 x 06 330 x 250 x 150 | 3,785 | 4,105 | - |



| CAT. MODEL | DIMENSIONS | | MRP (₹) | | |
|------------------|------------------------|-----------------------------------|---------|-------|--------------|
| | Overall Size (inch/mm) | Bowl Size (inch/mm) | Glossy | Matt | Anti-Scratch |
| SBF 06 (Classic) | 24 x 18 610 x 460 | 20.5 x 15 x 08 520 x 380 x 200 | 6,555 | 6,895 | - |



| CAT. MODEL | DIMENSIONS | | MRP (₹) | | |
|-------------|------------------------|---------------------------------|---------|-------|--------------|
| | Overall Size (inch/mm) | Bowl Size (inch/mm) | Glossy | Matt | Anti-Scratch |
| SBF 05 | 24 x 18 610 x 460 | 20 x 16 x 07 510 x 404 x 178 | 6,210 | 6,530 | - |
| SBF 06 | 24 x 18 610 x 460 | 20 x 16 x 08 510 x 404 x 200 | 6,440 | 6,770 | 9,710 |
| SBF 06 (DX) | 24 x 18 610 x 460 | 20 x 16 x 10 510 x 404 x 250 | 8,025 | 8,350 | - |
| SBF 07 | 24 x 18 610 x 460 | 20 x 16 x 09 510 x 404 x 225 | 7,285 | 7,615 | - |

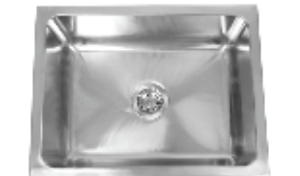

| CAT. MODEL | DIMENSIONS | | MRP (₹) | | |
|------------|------------------------|---------------------------------|---------|-------|--------------|
| | Overall Size (inch/mm) | Bowl Size (inch/mm) | Glossy | Matt | Anti-Scratch |
| SBF 06 A | 24 x 18 610 x 460 | 22 x 16 x 08 550 x 404 x 200 | 6,550 | 6,800 | - |
| SBF 07 A | 24 x 18 610 x 460 | 22 x 16 x 09 550 x 404 x 225 | 7,390 | 7,640 | - |



| CAT. MODEL | DIMENSIONS | | MRP (₹) | | |
|-------------|------------------------|---------------------------------|---------|--------|--------------|
| | Overall Size (inch/mm) | Bowl Size (inch/mm) | Glossy | Matt | Anti-Scratch |
| SBF 08 | 27 x 20 685 x 510 | 24 x 18 x 08 600 x 450 x 200 | 8,520 | 8,840 | - |
| SBF 08 (DX) | 27 x 20 685 x 510 | 24 x 18 x 10 600 x 450 x 250 | 10,495 | 10,840 | - |



| CAT. MODEL | DIMENSIONS | | MRP (₹) | | |
|------------|------------------------|---------------------------------|---------|--------|--------------|
| | Overall Size (inch/mm) | Bowl Size (inch/mm) | Glossy | Matt | Anti-Scratch |
| SBF 10 | 22 x 22 560 x 560 | 20 x 20 x 10 510 x 510 x 250 | 12,110 | 12,430 | - |



| CAT. MODEL | DIMENSIONS | | MRP (₹) | | |
|------------|------------------------|---------------------------------|---------|-------|--------------|
| | Overall Size (inch/mm) | Bowl Size (inch/mm) | Glossy | Matt | Anti-Scratch |
| SBF 09 | 24 x 20 610 x 510 | 22 x 17 x 08 560 x 430 x 200 | 6,555 | 6,900 | - |



| CAT. MODEL | DIMENSIONS | | MRP (₹) | | |
|------------|------------------------|---------------------------------|---------|-------|--------------|
| | Overall Size (inch/mm) | Bowl Size (inch/mm) | Glossy | Matt | Anti-Scratch |
| SBF 09A | 24 x 20 610 x 510 | 21 x 17 x 08 535 x 432 x 200 | 6,555 | 6,900 | 9,290 |



| CAT. MODEL | DIMENSIONS | | MRP (₹) | | |
|----------------------|------------------------|-----------------------------------|---------|-------|--------------|
| | Overall Size (inch/mm) | Bowl Size (inch/mm) | Glossy | Matt | Anti-Scratch |
| SBF 09 B | 24 x 20 610 x 510 | 20.5 x 15 x 08 520 x 380 x 200 | 6,680 | 7,015 | - |
| SBF 09 C (with Hole) | 24 x 20 610 x 510 | 20.5 x 15 x 08 520 x 380 x 200 | 6,680 | 7,015 | - |

JUPITER (Sinks with Drain Board)



| CAT. MODEL | DIMENSIONS | | MRP (₹) | | |
|------------|------------------------|---------------------------------|---------|------|--------------|
| | Overall Size (inch/mm) | Bowl Size (inch/mm) | Glossy | Matt | Anti-Scratch |
| SBSD 2418 | 24 x 18 610 x 458 | 16 x 14 x 08 408 x 356 x 203 | 6450 | 6750 | - |



WE ARE COMMITTED TO MAINTAIN OUR QUALITY

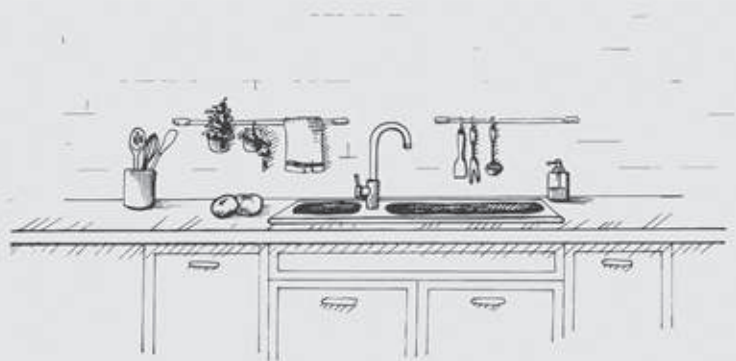

Jayna products are designed engineered and produced with world-class manufacturing standard. The products are crafted using high-grade stainless steel with strict quality norms to ensure consistency.



| CAT. MODEL | DIMENSIONS | | MRP (₹) | | |
|--------------|------------------------|---------------------------------|---------|-------|--------------|
| | Overall Size (inch/mm) | Bowl Size (inch/mm) | Glossy | Matt | Anti-Scratch |
| SBSD 01 | 32 x 20 810 x 510 | 14 x 16 x 07 352 x 410 x 178 | 7,535 | 7,980 | 10,810 |
| SBSD 01 (DX) | 32 x 20 810 x 510 | 14 x 16 x 09 352 x 410 x 225 | 9,060 | 9,505 | - |



| CAT. MODEL | DIMENSIONS | | MRP (₹) | | |
|-------------|------------------------|---------------------------------|---------|-------|--------------|
| | Overall Size (inch/mm) | Bowl Size (inch/mm) | Glossy | Matt | Anti-Scratch |
| SBSD 01 (A) | 30 x 20 760 x 510 | 14 x 16 x 08 352 x 410 x 200 | 7,535 | 7,980 | - |



| CAT. MODEL | DIMENSIONS | | MRP (₹) | | |
|--------------|------------------------|---------------------------------|---------|-------|--------------|
| | Overall Size (inch/mm) | Bowl Size (inch/mm) | Glossy | Matt | Anti-Scratch |
| SBSD 01 (RR) | 32 x 18 810 x 460 | 16 x 14 x 08 410 x 352 x 200 | 7,240 | 7,640 | - |



| CAT. MODEL | DIMENSIONS | | MRP (₹) | | |
|-------------|------------------------|---------------------------------|---------|-------|--------------|
| | Overall Size (inch/mm) | Bowl Size (inch/mm) | Glossy | Matt | Anti-Scratch |
| SBSD 01 (B) | 32 x 20 810 x 510 | 14 x 16 x 08 352 x 410 x 200 | 8,755 | 9,185 | - |



| CAT. MODEL | DIMENSIONS | | MRP (₹) | | |
|--------------|------------------------|---------------------------------|---------|-------|--------------|
| | Overall Size (inch/mm) | Bowl Size (inch/mm) | Glossy | Matt | Anti-Scratch |
| SBSD 02 (RR) | 37 x 18 940 x 460 | 16 x 14 x 08 410 x 352 x 200 | 7,810 | 8,265 | - |
| SBSD 05 (RR) | 36 x 18 915 x 460 | 16 x 14 x 08 410 x 352 x 200 | 7,810 | 8,265 | - |
| SBSD 05 (DX) | 36 x 18 915 x 460 | 16 x 14 x 09 410 x 352 x 225 | 9,060 | 9,505 | - |



| CAT. MODEL | DIMENSIONS | | MRP (₹) | | |
|--------------|------------------------|---------------------------------|---------|-------|--------------|
| | Overall Size (inch/mm) | Bowl Size (inch/mm) | Glossy | Matt | Anti-Scratch |
| SBSD 02 | 37 x 18.5 940 x 465 | 17 x 15 x 07 428 x 378 x 178 | 7,940 | 8,405 | - |
| SBSD 02 (DX) | 37 x 18.5 940 x 465 | 17 x 15 x 09 428 x 378 x 225 | 9,445 | 9,900 | - |



| CAT. MODEL | DIMENSIONS | | MRP (₹) | | |
|--------------|------------------------|---------------------------------|---------|--------|--------------|
| | Overall Size (inch/mm) | Bowl Size (inch/mm) | Glossy | Matt | Anti-Scratch |
| SBSD 03 (DX) | 36 x 20 915 x 510 | 24 x 18 x 09 600 x 450 x 225 | 11,830 | 12,290 | - |



| CAT. MODEL | DIMENSIONS | | MRP (₹) | | |
|------------|------------------------|---------------------------------|---------|-------|--------------|
| | Overall Size (inch/mm) | Bowl Size (inch/mm) | Glossy | Matt | Anti-Scratch |
| SBSD 03 | 36 x 20 915 x 510 | 18 x 16 x 09 460 x 400 x 225 | 9,520 | 9,970 | - |



| CAT. MODEL | DIMENSIONS | | MRP (₹) | | |
|-------------------|------------------------|---------------------------------|---------|--------|--------------|
| | Overall Size (inch/mm) | Bowl Size (inch/mm) | Glossy | Matt | Anti-Scratch |
| SBSD 03 (Premium) | 36 x 20 915 x 510 | 20 x 16 x 09 510 x 404 x 225 | 10,095 | 10,545 | - |



| CAT. MODEL | DIMENSIONS | | MRP (₹) | | |
|------------|------------------------|---------------------------------|---------|--------|--------------|
| | Overall Size (inch/mm) | Bowl Size (inch/mm) | Glossy | Matt | Anti-Scratch |
| SBSD 03 A | 36 x 19 915 x 482 | 18 x 15 x 09 460 x 380 x 225 | 9,690 | 10,185 | - |



| CAT. MODEL | DIMENSIONS | | MRP (₹) | | |
|--------------|------------------------|---------------------------------|---------|--------|--------------|
| | Overall Size (inch/mm) | Bowl Size (inch/mm) | Glossy | Matt | Anti-Scratch |
| SBSD 04 (RR) | 45 x 20 1145 x 510 | 20 x 16 x 08 510 x 404 x 200 | 11,620 | 12,080 | - |



| CAT. MODEL | DIMENSIONS | | MRP (₹) | | |
|--------------|------------------------|---------------------------------|---------|--------|--------------|
| | Overall Size (inch/mm) | Bowl Size (inch/mm) | Glossy | Matt | Anti-Scratch |
| SBSD 04 | 45 x 20 1145 x 510 | 22 x 16 x 08 550 x 404 x 200 | 11,795 | 12,250 | - |
| SBSD 04 (DX) | 45 x 20 1145 x 510 | 22 x 16 x 10 550 x 404 x 250 | 13,170 | 13,790 | - |



| CAT. MODEL | DIMENSIONS | | MRP (₹) | | |
|--------------|------------------------|---------------------------------|---------|-------|--------------|
| | Overall Size (inch/mm) | Bowl Size (inch/mm) | Glossy | Matt | Anti-Scratch |
| SBSD 05 (RR) | 36 x 18 915 x 460 | 16 x 14 x 08 410 x 352 x 200 | 7,810 | 8,265 | - |
| SBSD 05 (DX) | 36 x 18 915 x 460 | 16 x 14 x 09 410 x 352 x 225 | 9,060 | 9,505 | - |



| CAT. MODEL | DIMENSIONS | | MRP (₹) | | |
|--------------|------------------------|---------------------------------|---------|--------|--------------|
| | Overall Size (inch/mm) | Bowl Size (inch/mm) | Glossy | Matt | Anti-Scratch |
| SBSD 06 | 42 x 20 1065 x 510 | 20 x 16 x 08 510 x 404 x 200 | 11,000 | 11,465 | 15,590 |
| SBSD 06 (DX) | 42 x 20 1065 x 510 | 20 x 16 x 10 510 x 404 x 250 | 12,875 | 13,325 | - |



| CAT. MODEL | DIMENSIONS | | MRP (₹) | | |
|------------|-------------------------|---------------------------------|---------|-------|--------------|
| | Overall Size (inch/mm) | Bowl Size (inch/mm) | Glossy | Matt | Anti-Scratch |
| SBSD 07 | 40 x 18.5 1020 x 465 | 18 x 15 x 08 460 x 380 x 200 | 8,535 | 8,985 | - |



| CAT. MODEL | DIMENSIONS | | MRP (₹) | | |
|----------------|------------------------|---------------------------------|---------|--------|--------------|
| | Overall Size (inch/mm) | Bowl Size (inch/mm) | Glossy | Matt | Anti-Scratch |
| SBSD 09 A | 41 x 20 1040 x 510 | 20 x 16 x 08 510 x 404 x 200 | 9,100 | 9,560 | - |
| SBSD 09 A (DX) | 41 x 20 1040 x 510 | 20 x 16 x 10 510 x 404 x 250 | 10,915 | 11,285 | - |



| CAT. MODEL | DIMENSIONS | | MRP (₹) | | |
|-------------------|---------------------------|---------------------------------|---------|-------|--------------|
| | Overall Size (inch/mm) | Bowl Size (inch/mm) | Glossy | Matt | Anti-Scratch |
| SBSD 09 (Premium) | 41 x 20 1040 x 510 | 18 x 16 x 07 460 x 400 x 178 | 8,870 | 9,330 | 13,530 |
| SBSD 09 B | 41 x 20 1040 x 510 | 18 x 16 x 08 460 x 400 x 200 | 9,015 | 9,470 | 13,940 |
| SBSD 09 C | 39.5 x 19.5 1000 x 500 | 18 x 16 x 08 460 x 400 x 200 | 9,445 | 9,900 | 13,940 |
| SBSD 09 D | 39.5 x 19.5 1000 x 500 | 22 x 16 x 08 550 x 400 x 200 | 9,445 | 9,900 | - |



| CAT. MODEL | DIMENSIONS | | MRP (₹) | | |
|---------------|------------------------|-----------------------------------|---------|--------|--------------|
| | Overall Size (inch/mm) | Bowl Size (inch/mm) | Glossy | Matt | Anti-Scratch |
| SBSD 10 (RHD) | 41 x 20 1040 x 510 | 20.5 x 15 x 08 520 x 380 x 200 | 14,365 | 14,825 | - |
| SBSD 10 (LHD) | 41 x 20 1040 x 510 | 20.5 x 15 x 08 520 x 380 x 200 | 14,365 | 14,825 | - |



| CAT. MODEL | DIMENSIONS | | MRP (₹) | | |
|--------------|-------------------------|---------------------------------|---------|--------|--------------|
| | Overall Size (inch/mm) | Bowl Size (inch/mm) | Glossy | Matt | Anti-Scratch |
| SBSD 08 | 56 x 22.5 1420 x 570 | 24 x 18 x 08 600 x 450 x 200 | 16,395 | 16,850 | - |
| SBSD 08 (DX) | 56 x 22.5 1420 x 570 | 24 x 18 x 10 600 x 450 x 250 | 19,330 | 19,785 | - |



| CAT. MODEL | DIMENSIONS | | MRP (₹) | | |
|---------------|------------------------|-------------------------------------|---------|--------|--------------|
| | Overall Size (inch/mm) | Bowl Size (inch/mm) | Glossy | Matt | Anti-Scratch |
| SBSD 11 (RHD) | 36 x 20 915 x 510 | 13.5 x 16.5 x 08 340 x 418 x 200 | 11,680 | 12,140 | - |
| SBSD 11 (LHD) | 36 x 20 915 x 510 | 13.5 x 16.5 x 08 340 x 418 x 200 | 11,680 | 12,140 | - |



| CAT. MODEL | DIMENSIONS | | MRP (₹) | | |
|-------------|---------------------------|---------------------------------|---------|--------|-------------|
| | Overall Size (inch/mm) | Bowl Size (inch/mm) | Glossy | Matt | Dual Finish |
| DBF 01 | 39.5 x 18.5 1000 x 465 | 17 x 15 x 08 428 x 378 x 200 | 12,410 | 12,960 | - |
| DBF 01 (DX) | 39.5 x 18.5 1000 x 465 | 17 x 15 x 09 428 x 378 x 225 | 14,655 | 15,195 | 16,780 |



| CAT. MODEL | DIMENSIONS | | MRP (₹) | | |
|-------------|------------------------|---------------------------------|---------|--------|-------------|
| | Overall Size (inch/mm) | Bowl Size (inch/mm) | Glossy | Matt | Dual Finish |
| DBF 02 | 45 x 20 1145 x 510 | 20 x 16 x 08 510 x 404 x 200 | 17,235 | 17,775 | - |
| DBF 02 (DX) | 45 x 20 1145 x 510 | 20 x 16 x 10 510 x 404 x 250 | 20,340 | 20,890 | - |



| CAT. MODEL | DIMENSIONS | | MRP (₹) | | |
|-------------|-------------------------|---------------------------------|---------|--------|-------------|
| | Overall Size (inch/mm) | Bowl Size (inch/mm) | Glossy | Matt | Dual Finish |
| DBF 03 | 32.75 x 20 832 x 510 | 14 x 16 x 08 352 x 410 x 200 | 12,410 | 13,355 | - |
| DBF 03 (DX) | 32.75 x 20 832 x 510 | 14 x 16 x 09 352 x 410 x 225 | 14,655 | 15,195 | 16,780 |



| CAT. MODEL | DIMENSIONS | | MRP (₹) | | |
|-------------|-------------------------|---------------------------------|---------|--------|-------------|
| | Overall Size (inch/mm) | Bowl Size (inch/mm) | Glossy | Matt | Dual Finish |
| DBF 04 | 56 x 22.5 1420 x 570 | 24 x 18 x 08 600 x 450 x 200 | 22,725 | 23,275 | - |
| DBF 04 (DX) | 56 x 22.5 1420 x 570 | 24 x 18 x 10 600 x 450 x 250 | 28,050 | 28,595 | - |



| CAT. MODEL | DIMENSIONS | | MRP (₹) | | |
|-------------|------------------------|---------------------------------|---------|--------|-------------|
| | Overall Size (inch/mm) | Bowl Size (inch/mm) | Glossy | Matt | Dual Finish |
| DBF 05 | 50 x 20 1270 x 510 | 22 x 16 x 08 550 x 404 x 200 | 20,520 | 21,060 | - |
| DBF 05 (DX) | 50 x 20 1270 x 510 | 22 x 16 x 10 550 x 404 x 250 | 23,865 | 24,410 | - |



| CAT. MODEL | DIMENSIONS | | MRP (₹) | | |
|-------------|------------------------|---------------------------------|---------|--------|-------------|
| | Overall Size (inch/mm) | Bowl Size (inch/mm) | Glossy | Matt | Dual Finish |
| DBF 06 | 37 x 18.5 940 x 465 | 16 x 14 x 08 408 x 352 x 200 | 12,410 | 12,960 | - |
| DBF 06 (DX) | 37 x 18.5 940 x 465 | 16 x 14 x 09 408 x 352 x 225 | 14,655 | 15,195 | 15,830 |



| CAT. MODEL | DIMENSIONS | | MRP (₹) | | |
|-------------|------------------------|---------------------------------|---------|--------|-------------|
| | Overall Size (inch/mm) | Bowl Size (inch/mm) | Glossy | Matt | Dual Finish |
| DBF 07 | 42 x 20 1065 x 510 | 18 x 16 x 08 460 x 405 x 200 | 16,735 | 17,280 | - |
| DBF 07 (DX) | 42 x 20 1065 x 510 | 18 x 16 x 09 460 x 405 x 225 | 19,765 | 20,290 | - |



| CAT. MODEL | DIMENSIONS | | MRP (₹) | | |
|-------------|------------------------|---------------------------------|---------|--------|-------------|
| | Overall Size (inch/mm) | Bowl Size (inch/mm) | Glossy | Matt | Dual Finish |
| DBF 08 | 37.5 x 20 950 x 510 | 16 x 16 x 08 405 x 405 x 200 | 15,055 | 15,590 | - |
| DBF 08 (DX) | 37.5 x 20 950 x 510 | 16 x 16 x 09 405 x 405 x 225 | 18,295 | 18,850 | - |



| CAT. MODEL | DIMENSIONS | | MRP (₹) | | |
|-------------------|------------------------|---------------------------------|---------|--------|-------------|
| | Overall Size (inch/mm) | Bowl Size (inch/mm) | Glossy | Matt | Dual Finish |
| DBF E01 | 33 x 22 840 x 560 | 14 x 15 x 08 355 x 380 x 200 | 13,900 | 14,435 | - |
| DBF E02 with Hole | 33 x 22 840 x 560 | 14 x 15 x 08 355 x 380 x 200 | 13,900 | 14,435 | - |

*Free Plumbing Connectors are provided with Apollo Range Sinks



| CAT. MODEL | DIMENSIONS | | MRP (₹) | | |
|--------------|---------------------------|---------------------------------|---------|--------|-------------|
| | Overall Size (inch/mm) | Bowl Size (inch/mm) | Glossy | Matt | Dual Finish |
| DBSD 01 | 54.5 x 18.5 1385 x 465 | 17 x 15 x 07 428 x 378 x 178 | 16,620 | 17,280 | - |
| DBSD 01 (DX) | 54.5 x 18.5 1385 x 465 | 17 x 15 x 09 428 x 378 x 225 | 18,855 | 19,510 | 21,595 |
| DBSD 05 A | 47 x 18 1200 x 460 | 16 x 14 x 08 408 x 356 x 200 | 16,620 | 17,280 | - |



| CAT. MODEL | DIMENSIONS | | MRP (₹) | | |
|--------------|-------------------------|---------------------------------|---------|--------|-------------|
| | Overall Size (inch/mm) | Bowl Size (inch/mm) | Glossy | Matt | Dual Finish |
| DBSD 02 | 66.5 x 20 1690 x 510 | 20 x 16 x 08 510 x 404 x 200 | 22,895 | 23,550 | - |
| DBSD 02 (DX) | 66.5 x 20 1690 x 510 | 20 x 16 x 10 510 x 404 x 250 | 26,245 | 26,905 | - |



| CAT. MODEL | DIMENSIONS | | MRP (₹) | | |
|--------------|------------------------|---------------------------------|---------|--------|-------------|
| | Overall Size (inch/mm) | Bowl Size (inch/mm) | Glossy | Matt | Dual Finish |
| DBSD 03 | 45 x 20 1145 x 510 | 14 x 16 x 08 352 x 410 x 200 | 16,620 | 17,280 | - |
| DBSD 03 (DX) | 45 x 20 1145 x 510 | 14 x 16 x 09 352 x 410 x 225 | 18,855 | 19,510 | - |



| CAT. MODEL | DIMENSIONS | | MRP (₹) | | |
|--------------|------------------------|---------------------------------|---------|--------|-------------|
| | Overall Size (inch/mm) | Bowl Size (inch/mm) | Glossy | Matt | Dual Finish |
| DBSD 04 | 61 x 20 1550 x 510 | 18 x 16 x 08 460 x 405 x 200 | 19,795 | 20,465 | - |
| DBSD 04 (DX) | 61 x 20 1550 x 510 | 18 x 16 x 09 460 x 405 x 225 | 22,050 | 22,695 | - |



| CAT. MODEL | DIMENSIONS | | MRP (₹) | | |
|------------|------------------------|---------------------------------|---------|--------|-------------|
| | Overall Size (inch/mm) | Bowl Size (inch/mm) | Glossy | Matt | Dual Finish |
| DBSD 05 | 47 x 20 1200 x 510 | 14 x 16 x 08 352 x 410 x 200 | 18,540 | 19,195 | - |



| CAT. MODEL | DIMENSIONS | | MRP (₹) | | |
|-------------|------------------------|---------------------------------|---------|--------|-------------|
| | Overall Size (inch/mm) | Bowl Size (inch/mm) | Glossy | Matt | Dual Finish |
| DBSD 01 (A) | 54 x 20 1370 x 510 | 16 x 16 x 08 405 x 405 x 200 | 20,645 | 21,285 | - |

*Free Plumbing Connectors are provided with Mercury Range Sinks

MARS (Single bowl with double drain board sinks)



| CAT. MODEL | DIMENSIONS | | MRP (₹) | | |
|------------|-------------------------|---------------------------------|---------|--------|-------------|
| | Overall Size (inch/mm) | Bowl Size (inch/mm) | Glossy | Matt | Dual Finish |
| SBDD 01 | 52 x 18.5 1320 x 465 | 17 x 15 x 08 428 x 378 x 200 | 14,650 | 15,305 | - |



| CAT. MODEL | DIMENSIONS | | MRP (₹) | | |
|------------|-------------------------|---------------------------------|---------|--------|-------------|
| | Overall Size (inch/mm) | Bowl Size (inch/mm) | Glossy | Matt | Dual Finish |
| SBDD 02 | 66.5 x 20 1690 x 510 | 20 x 16 x 08 510 x 404 x 200 | 19,000 | 19,635 | - |

VENUS (Double bowl with double Drain board sinks)



| CAT. MODEL | DIMENSIONS | | MRP (₹) | | |
|------------|---------------------------|---------------------------------|---------|--------|-------------|
| | Overall Size (inch/mm) | Bowl Size (inch/mm) | Glossy | Matt | Dual Finish |
| DBDD 01 | 69.5 x 18.5 1765 x 465 | 17 x 15 x 08 428 x 378 x 200 | 26,075 | 26,750 | - |



| CAT. MODEL | DIMENSIONS | | MRP (₹) | | |
|------------|------------------------|---------------------------------|---------|--------|-------------|
| | Overall Size (inch/mm) | Bowl Size (inch/mm) | Glossy | Matt | Dual Finish |
| DBDD 02 | 61 x 20 1550 x 510 | 14 x 16 x 08 352 x 410 x 200 | 24,265 | 24,930 | - |

*Free Plumbing Connectors are provided with Venus Range Sinks

ZODIAC (Sinks With Garbage Bin)



| CAT. MODEL | DIMENSIONS | | MRP (₹) | | |
|------------|------------------------|---------------------------------|---------|--------|-------------|
| | Overall Size (inch/mm) | Bowl Size (inch/mm) | Glossy | Matt | Dual Finish |
| SBGB 01 | 32 x 20 810 x 510 | 20 x 16 x 08 510 x 404 x 200 | 12,825 | 13,380 | - |



| CAT. MODEL | DIMENSIONS | | MRP (₹) | | |
|------------|------------------------|---------------------------------|---------|--------|-------------|
| | Overall Size (inch/mm) | Bowl Size (inch/mm) | Glossy | Matt | Dual Finish |
| SBGB 02 | 48 x 20 1220 x 510 | 20 x 16 x 08 510 x 404 x 200 | 16,835 | 17,390 | - |



| CAT. MODEL | DIMENSIONS | | MRP (₹) | | |
|------------|------------------------|---|---------|--------|-------------|
| | Overall Size (inch/mm) | Bowl Size (inch/mm) | Glossy | Matt | Dual Finish |
| DBGB 03 | 48 x 20 1220 x 510 | 20 x 16 x 08 (Big) 510 x 404 x 200 14 x 16 x 08 (MB) 352 x 410 x 200 | 19,680 | 20,360 | - |



| CAT. MODEL | DIMENSIONS | | MRP (₹) | | |
|------------|------------------------|---|---------|--------|-------------|
| | Overall Size (inch/mm) | Bowl Size (inch/mm) | Glossy | Matt | Dual Finish |
| DBGB 04 | 62 x 20 1575 x 510 | 20 x 16 x 08 (Big) 510 x 404 x 200 14 x 16 x 08 (MB) 352 x 410 x 200 | 23,880 | 24,445 | 25,905 |

How ZODIAC works



1. Open the garbage bin cover.
(Note it's in the middle)
2. Then pour your garbage without hesitation.
3. Later draw out the bin and dispose the garbage elsewhere.



• Free Plumbing Connector is provided with Zodiac Range

SYMPHONY (Corner Sinks)



| CAT. MODEL | DIMENSIONS | | MRP (₹) | | |
|------------|------------------------|---------------------------------|---------|--------|-------------|
| | Overall Size (inch/mm) | Bowl Size (inch/mm) | Glossy | Matt | Dual Finish |
| CS 01 | 36 x 36 915 x 915 | 14 x 16 x 08 352 x 410 x 200 | 23,755 | 24,410 | - |



| CAT. MODEL | DIMENSIONS | | MRP (₹) | | |
|------------|------------------------|---------------------------------|---------|--------|-------------|
| | Overall Size (inch/mm) | Bowl Size (inch/mm) | Glossy | Matt | Dual Finish |
| CS 03 | 33 x 33 840 x 840 | 14 x 16 x 08 352 x 410 x 200 | 23,755 | 24,410 | 26,065 |



| CAT. MODEL | DIMENSIONS | | MRP (₹) | | |
|------------|------------------------|---|---------|--------|-------------|
| | Overall Size (inch/mm) | Bowl Size (inch/mm) | Glossy | Matt | Dual Finish |
| SBMB 01 | 32 x 20 810 x 510 | 20 x 16 x 08 (Big) 510 x 404 x 200 | 12,075 | 12,635 | - |
| | | 6.5 x 10.5 x 05 (MB) 170 x 270 x 125 | | | |



| CAT. MODEL | DIMENSIONS | | MRP (₹) | | |
|----------------------------|------------------------|---|---------|--------|-------------|
| | Overall Size (inch/mm) | Bowl Size (inch/mm) | Glossy | Matt | Dual Finish |
| SBMB 02 (with Drain Board) | 48 x 20 1220 x 510 | 20 x 16 x 08 (Big) 510 x 404 x 200 | 16,070 | 16,630 | - |
| | | 6.5 x 10.5 x 05 (MB) 170 x 270 x 125 | | | |



| CAT. MODEL | DIMENSIONS | | MRP (₹) | | |
|------------|------------------------|---|---------|--------|-------------|
| | Overall Size (inch/mm) | Bowl Size (inch/mm) | Glossy | Matt | Dual Finish |
| DBMB 03 | 48 x 20 1220 x 510 | 20 x 16 x 08 (Big) 510 x 404 x 200 | 19,060 | 19,620 | - |
| | | 14 x 16 x 08 (Small) 352 x 410 x 200 | | | |
| | | 6.5 x 10.5 x 05 (MB) 170 x 270 x 125 | | | |



| CAT. MODEL | DIMENSIONS | | MRP (₹) | | |
|------------|------------------------|---|---------|--------|-------------|
| | Overall Size (inch/mm) | Bowl Size (inch/mm) | Glossy | Matt | Dual Finish |
| SBMB 04 | 41 x 20 1040 x 510 | 14 x 16 x 08 (Big) 352 x 410 x 200 | 15,295 | 15,840 | 17,595 |
| | | 6.5 x 10.5 x 05 (MB) 170 x 270 x 125 | | | |



| CAT. MODEL | DIMENSIONS | | MRP (₹) | | |
|------------|------------------------|---|---------|--------|-------------|
| | Overall Size (inch/mm) | Bowl Size (inch/mm) | Glossy | Matt | Dual Finish |
| SBMB 05 | 45 x 20 1145 x 510 | 20 x 16 x 08 (Big) 510 x 404 x 200 | 18,145 | 18,700 | - |
| | | 6.5 x 10.5 x 05 (MB) 170 x 270 x 125 | | | |



| CAT. MODEL | DIMENSIONS | | MRP (₹) | | |
|------------|------------------------|---|---------|--------|-------------|
| | Overall Size (inch/mm) | Bowl Size (inch/mm) | Glossy | Matt | Dual Finish |
| DBMB 05 | 41 x 20 1040 x 510 | 14 x 16 x 08 (Big) 352 x 410 x 200 | 18,145 | 18,700 | - |
| | | 6.5 x 10.5 x 05 (MB) 170 x 270 x 125 | | | |



| CAT. MODEL | DIMENSIONS | | MRP (₹) | | |
|------------|------------------------|--|---------|--------|-------------|
| | Overall Size (inch/mm) | Bowl Size (inch/mm) | Glossy | Matt | Dual Finish |
| SBMB 06 | 30 x 20 760 x 510 | 14 x 16 x 08 (Big) 352 x 410 x 200 | 12,075 | 12,635 | 13,870 |
| | | 6.5 x 10.5 x 05 (Small) 170 x 270 x 125 | | | |



| CAT. MODEL | DIMENSIONS | | MRP (₹) | | |
|---------------|------------------------|---|---------|--------|-------------|
| | Overall Size (inch/mm) | Bowl Size (inch/mm) | Glossy | Matt | Dual Finish |
| DBMB 07 (RHD) | 41 x 20 1040 x 510 | 14 x 16 x 08 (Big) 352 x 410 x 200 | 16,735 | 17,280 | - |
| DBMB 07 (LHD) | | 10 x 13 x 06 (Small) 250 x 328 x 150 | | | |

*Drain Board can be placed on LHS or RHS as per demand



| CAT. MODEL | DIMENSIONS | | MRP (₹) | | |
|---------------|------------------------|---|---------|--------|-------------|
| | Overall Size (inch/mm) | Bowl Size (inch/mm) | Glossy | Matt | Dual Finish |
| SBMB 08 (RHD) | 41 x 20 1040 x 510 | 14 x 16 x 08 (Big) 352 x 410 x 200 | 17,760 | 18,310 | - |
| SBMB 08 (LHD) | | 6.5 x 10.5 x 05 (MB) 170 x 270 x 125 | | | |



| CAT. MODEL | DIMENSIONS | | MRP (₹) | | |
|------------|------------------------|---|---------|--------|-------------|
| | Overall Size (inch/mm) | Bowl Size (inch/mm) | Glossy | Matt | Dual Finish |
| SBMB 09 | 41 x 20 1040 x 510 | 13.5 x 16.5 x 08 (Big) 340 x 418 x 200 | 17,760 | 18,310 | - |
| | | 6.5 x 12 x 05 (MB) 165 x 310 x 125 | | | |

*Exclusive Plumbing Connectors are provided with Cat. Model No. SBMB 08 & 09

*Free Plumbing Connectors are provided with Jubilee Range Sinks

CROWN (Single Bowl Sinks In 1.5 mm Thickness)



| CAT. MODEL | DIMENSIONS | | MRP (₹) | |
|------------------|------------------------|---------------------------------|---------|-------|
| | Overall Size (inch/mm) | Bowl Size (inch/mm) | Glossy | Matt |
| CSB 01 1.5 mm | 19 x 16 480 x 408 | 16 x 14 x 07 410 x 352 x 178 | 6,695 | 7,015 |



| CAT. MODEL | DIMENSIONS | | MRP (₹) | |
|------------------|------------------------|---------------------------------|---------|-------|
| | Overall Size (inch/mm) | Bowl Size (inch/mm) | Glossy | Matt |
| CSB 04 1.5 mm | 24 x 18 610 x 460 | 20 x 16 x 08 500 x 400 x 200 | 9,645 | 9,965 |



| CAT. MODEL | DIMENSIONS | | MRP (₹) | |
|------------------|------------------------|---------------------------------|---------|-------|
| | Overall Size (inch/mm) | Bowl Size (inch/mm) | Glossy | Matt |
| CSB 02 1.5 mm | 20 x 17 510 x 430 | 17 x 15 x 08 428 x 380 x 200 | 7,345 | 7,660 |
| CSB 03 1.5 mm | 21 x 18 535 x 460 | 18 x 15 x 08 460 x 380 x 200 | 8,440 | 8,775 |



| CAT. MODEL | DIMENSIONS | | MRP (₹) | |
|------------------|------------------------|---------------------------------|---------|--------|
| | Overall Size (inch/mm) | Bowl Size (inch/mm) | Glossy | Matt |
| CSB 05 1.5 mm | 27 x 20 685 x 510 | 24 x 18 x 08 600 x 450 x 200 | 12,465 | 12,780 |
| CSB 06 1.5 mm | 27 x 20 685 x 510 | 24 x 18 x 10 600 x 450 x 250 | 15,320 | 15,655 |

ATLAS (Sinks In 0.8 mm Thickness)



| CAT. MODEL | DIMENSIONS | | MRP (₹) | |
|------------------|------------------------|---------------------------------|---------|-------|
| | Overall Size (inch/mm) | Bowl Size (inch/mm) | Glossy | Matt |
| ATL 01 0.8 mm | 19 x 16 480 x 405 | 16 x 14 x 07 408 x 350 x 180 | 4,110 | 4,440 |



| CAT. MODEL | DIMENSIONS | | MRP (₹) | |
|------------------|------------------------|----------------------------------|---------|-------|
| | Overall Size (inch/mm) | Bowl Size (inch/mm) | Glossy | Matt |
| ATL 02 0.8 mm | 20 x 17 510 x 430 | 17 x 15 x 7.5 430 x 380 x 190 | 4,345 | 4,685 |



| CAT. MODEL | DIMENSIONS | | MRP (₹) | |
|------------------|------------------------|----------------------------------|---------|-------|
| | Overall Size (inch/mm) | Bowl Size (inch/mm) | Glossy | Matt |
| ATL 03 0.8 mm | 21 x 18 530 x 460 | 18 x 15 x 7.5 458 x 380 x 190 | 4,985 | 5,325 |
| ATL 04 0.8 mm | 24 x 18 610 x 460 | 20 x 16 x 08 500 x 400 x 200 | 5,890 | 6,235 |



| CAT. MODEL | DIMENSIONS | | MRP (₹) | |
|------------------|------------------------|---------------------------------|---------|-------|
| | Overall Size (inch/mm) | Bowl Size (inch/mm) | Glossy | Matt |
| ATL 05 0.8 mm | 36 x 18 915 x 460 | 16 x 14 x 07 408 x 350 x 180 | 6,750 | 7,080 |



| CAT. MODEL | DIMENSIONS | | MRP (₹) | |
|------------|------------------------|-------------------------------------|---------|-------|
| | Overall Size (inch/mm) | Bowl Size (inch/mm) | Glossy | Matt |
| WB 01 | 18 x 12 460 x 300 | 15.5 x 7.5 x 5.5 390 x 190 x 140 | 2,695 | 3,075 |
| WB 02 | 21 x 14 530 x 352 | 18 x 10.5 x 6 457 x 257 x 150 | 4,085 | 4,440 |
| WB 03 | 21 x 15 530 x 380 | 18 x 10.5 x 6 457 x 257 x 150 | 4,380 | 4,750 |



| CAT. MODEL | DIMENSIONS | | MRP (₹) | |
|------------|------------------------|----------------------------------|---------|-------|
| | Overall Size (inch/mm) | Bowl Size (inch/mm) | Glossy | Matt |
| WB 04 | 12 x 12 305 x 305 | 10 x 09 x 4.5 255 x 230 x 115 | 3,215 | 3,320 |



| CAT. MODEL | DIMENSIONS | | MRP (₹) | |
|------------|------------------------|----------------------------------|---------|-------|
| | Overall Size (inch/mm) | Bowl Size (inch/mm) | Glossy | Matt |
| WB 05 | 14 x 18.5 356 x 470 | 10 x 16.5 x 6 250 x 420 x 150 | 3,495 | 3,870 |

NEPTUNE (Lavatory Pans)



| CAT. MODEL | DIMENSIONS | | MRP (₹) | |
|-----------------------------|------------------------|---------------------|---------|-------|
| | Overall Size (inch/mm) | Bowl Size (inch/mm) | Glossy | Matt |
| LP 01 (Without Flushing) | 724 x 578 | 4" Outlet 100 mm | 8,810 | 9,135 |



| CAT. MODEL | DIMENSIONS | | MRP (₹) | |
|--------------------------|------------------------|---------------------|---------|--------|
| | Overall Size (inch/mm) | Bowl Size (inch/mm) | Glossy | Matt |
| LP 02 (With Flushing) | 724 x 578 | 4" Outlet 100 mm | 10,270 | 10,595 |



| CAT. MODEL | DIMENSIONS | | MRP (₹) | |
|-----------------------------|------------------------|---------------------|---------|-------|
| | Overall Size (inch/mm) | Bowl Size (inch/mm) | Glossy | Matt |
| LP 03 (Without Flushing) | 23 x 19 585 x 480 | 4" Outlet 100 mm | 6,730 | 7,050 |



| CAT. MODEL | DIMENSIONS | | MRP (₹) | |
|--------------------------|------------------------|---------------------|---------|-------|
| | Overall Size (inch/mm) | Bowl Size (inch/mm) | Glossy | Matt |
| LP 04 (With Flushing) | 23 x 19 585 x 480 | 4" Outlet 100 mm | 7,675 | 7,995 |



| CAT. MODEL | DIMENSIONS | | MRP (₹) | |
|-----------------------------|------------------------|---------------------|---------|-------|
| | Overall Size (inch/mm) | Bowl Size (inch/mm) | Glossy | Matt |
| LP 05 (Without Flushing) | 630 x 595 | 4" Outlet 100 mm | 8,125 | 8,455 |



| CAT. MODEL | DIMENSIONS | | MRP (₹) | |
|--------------------------|------------------------|---------------------|---------|-------|
| | Overall Size (inch/mm) | Bowl Size (inch/mm) | Glossy | Matt |
| LP 06 (With Flushing) | 630 x 595 | 4" Outlet 100 mm | 9,045 | 9,385 |



Sanitary Essentials ▶

AISI 304 | RUST | 100%
18/8 STEEL | PROOF | Non-Magnetic

Sanitaryware at public places is exposed to heavy usage and high maintenance. Jayna Provides durable products crafted in 1 mm and 1.2 mm stainless steel thickness for sustainable use.

The urinals, troughs, basins & washing table are available in different designs and varied sizes and are easy to clean and maintain for everyday use.



BUILT
TO LAST

SANITARY ESSENTIALS (Crafted In 1mm & 1.2mm, International Satin Finish)



Commercial Sink

- Thickness: 1.2 mm
- Overall Dimension: 1600 x 510 x 475 mm
- Bowl Dimension: 350 x 400 x 225 mm
- Mixer Hole: Two 35 mm
- Rear Splashback: Included

| DIMENSIONS | | MRP (₹) |
|------------|-------------------|---------|
| Cat. Model | Overall Size (mm) | Matt |
| JCS 01 | 1600 x 510 x 475 | 62,500 |



Urinal Pod

- Thickness: 1.2 mm
- Overall Width: 250 mm
- Overall Height: 600 mm
- Overall Length: 400 mm
- Type of Mounting: Wall Mounting
- Waste Size: 46 mm
- Water Inlet: Exposed
- Water Outlet: Concealed
- Exposed Sparge Pipe Included

| DIMENSIONS | | MRP (₹) |
|------------|-------------------|---------|
| Cat. Model | Overall Size (mm) | Matt |
| SUP 01 A | 400 mm | 21,145 |



Hand Wash Trough

- Thickness: 1.2 mm
- Overall Width: 420 mm
- Overall Height: 350 mm
- Basin Depth: 150 mm
- Type of Mounting: Wall Mounting
- Waste Size: 50 mm
- Rear Splashback: Included 200 mm

| DIMENSIONS | | | MRP (₹) |
|------------|-------------------|------------------|---------|
| Cat. Model | Overall Size (mm) | Bowl Size (mm) | Matt |
| HWT 01 | 900 mm | 800 x 295 x 150 | 26,045 |
| HWT 02 | 1200 mm | 1100 x 295 x 150 | 34,260 |



Urinal

- Thickness: 1.2 mm
- Overall Width: 235 mm
- Overall Height: 650 mm
- Type of Mounting: Wall Mounting
- Waste Size: 46 mm
- Water Inlet: Exposed
- Water Outlet: Concealed
- Exposed Sparge Pipe: Included

| DIMENSIONS | | MRP (₹) |
|------------|-------------------|---------|
| Cat. Model | Overall Size (mm) | Matt |
| MUP 01 | 900 mm | 36,950 |
| MUP 02 | 1200 mm | 48,680 |
| MUP 03 | 1500 mm | 60,410 |
| MUP 04 | 1800 mm | 73,020 |



Hand Wash Trough

- Thickness: 1.2 mm
- Overall Width: 420 mm
- Overall Height: 170 mm
- Basin Depth: 150 mm
- Type of Mounting: Wall Mounting
- Waste Size: 50 mm

| DIMENSIONS | | | MRP (₹) |
|------------|-------------------|------------------|---------|
| Cat. Model | Overall Size (mm) | Bowl Size (mm) | Matt |
| HWT 03 | 900 mm | 800 x 295 x 150 | 21,700 |
| HWT 04 | 1200 mm | 1100 x 295 x 150 | 29,910 |



Tissue Dispenser Box

- Thickness: 1.2 mm
- Type of Mounting: Wall Mounting
- Overall Dimension: 440 x 205 x 1520 mm
- Waste receptacle : Included

| DIMENSIONS | | MRP (₹) |
|------------|-------------------|---------|
| Cat. Model | Overall Size (mm) | Matt |
| TDB 01 | 440 x 205 x 1520 | 47,620 |



Hand Free Wash Sink

- Material : SS304
- Operation : Foot Pedal Operated Faucet and hand wash soap dispenser
- Rear Splashback : 200 (mm) Included
- Faucet : Included

| DIMENSIONS | | | MRP (₹) |
|------------|-------------------|-----------------|---------|
| Cat. Model | Overall Size (mm) | Bowl Size | |
| HFWS | 500 x 530 x 1063 | 400 x 377 x 200 | 40,820 |



Hand Wash Basin (Hospital Use)

- Thickness: 1.2 mm
- Operation: Knee Operated Basin
- Rear Splashback: Included 190 mm
- Type of Mounting: Wall Mounting
- Overall Dimension: 400 x 320 x 505 mm
- Drainage: Included

| DIMENSIONS | | | MRP (₹) |
|------------|-------------------|-----------------|---------|
| Cat. Model | Overall Size (mm) | Bowl Size (mm) | Matt |
| HWB 01 | 400 x 320 x 505 | 315 x 225 x 140 | 25,700 |



Scrub Sink

- Material : SS304
- Thickness : 1.2 MM
- Water Arrangement : Hot & Cold
- Operation : Foot Pedal operated Faucet
- Front Panel : Removable with key
- Operation Height : 910 MM

| DIMENSIONS | | MRP (₹) |
|------------|-------------------|----------|
| Cat. Model | Overall Size (mm) | |
| SS1BAY | 600 x 508 x 1360 | 80,500 |
| SS2BAY | 1300 x 508 x 1360 | 1,49,500 |

**Customization possible for bulk orders on request



SINK DRAINER

| CAT. MODEL | Size (mm) | MRP (₹) |
|------------|-----------|---------|
| DR 01 | Ø 114 | 850 |



SINK DRAINER (Small)

| CAT. MODEL | Size (mm) | MRP (₹) |
|------------|-----------|---------|
| DR 02 | Ø 70 | 300 |



SINK STRAINER

| CAT. MODEL | Size (mm) | MRP (₹) |
|------------|-----------|---------|
| DR 03 | Ø 70 | 350 |



STAINLESS STEEL DRAINER CAP

| CAT. MODEL | Size (mm) | MRP (₹) |
|------------|-----------|---------|
| DC 01 | Ø 114 | 855 |



ROLL MATT (Square)

| CAT. MODEL | Size (mm) | MRP (₹) |
|------------|-----------|---------|
| RMS 01 | 440 x 440 | 4,455 |

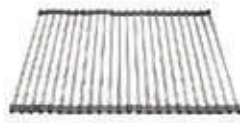

ROLL MATT (Round)

| CAT. MODEL | Size (mm) | MRP (₹) |
|------------|-----------|---------|
| RMR 02 | 440 x 440 | 3,825 |



Glass Rinser

| CAT. MODEL | Finish | MRP (₹) |
|------------|--------|---------|
| JGR 01 | Chrome | 5500 |



Wooden Chopping Board

| CAT. MODEL | MRP (₹) |
|------------|---------|
| WCB 06 | 2700 |



DRAIN TRAY

| CAT. MODEL | Description | MRP (₹) | |
|------------|-------------|---------|-------|
| | | Glossy | Matt |
| MT 01 | 16 x 14 | 4,335 | 4,745 |
| MT 02 | 20 x 16 | 5,650 | 6,060 |
| MT 03 | 16 x 16 | 4,945 | 5,355 |



Soap Dispenser
For a convenient access to the soap for washing hands or utensils to maintain a hygienic work environment.

| Soap Dispenser | | |
|----------------|---------------|---------|
| CAT. MODEL | Suitable for | MRP (₹) |
| SDR 01 | Designo Sinks | 2,490 |



STAINLESS STEEL CROCKERY BASKET

| CAT. MODEL | Description | MRP (₹) |
|------------|-------------|---------|
| | | Glossy |
| SSCB 01 | 16 x 14 | 1,180 |
| SSCB 02 | 17 x 15 | 1,450 |
| SSCB 03 | 18 x 15 | 1,450 |
| SSCB 04 | 20 x 16 | 1,925 |



PLUMBING CONNECTOR

| CAT. MODEL | M.R.P (₹) |
|------------|-----------|
| PC 01 | 805 |



PLUMBING CONNECTOR WITH BOTTLE TRAP

| CAT. MODEL | M.R.P (₹) |
|------------|-----------|
| PC 02 | 1,500 |

*Plumbing Connector for maximum length of 600 mm



BOTTLE TRAP

| CAT. MODEL | M.R.P (₹) |
|------------|-----------|
| BT 01 | 805 |



BOTTLE TRAP

| CAT. MODEL | M.R.P (₹) |
|------------|-----------|
| BT 02 | 805 |

* Ø 1-1/2 inch inlet & Ø 40 mm outlet

* Ø 1-1/4 inch inlet & Ø 40 mm outlet



PVC FLEXIBLE WASTE PIPE

| CAT. MODEL | M.R.P (₹) |
|------------|-----------|
| FP 02 | 255 |

* Ø 1-1/2 inch inlet / Ø 1-1/4 inch inlet & Ø 32 mm outlet



| PRODUCT DESCRIPTION & DIMENSIONS | | MRP (₹) | |
|----------------------------------|---|---------|-------|
| CAT. MODEL | Features / Size | Glossy | Matt |
| RB 01 | Stainless Steel Round Basin (With hole) Thickness: 1.0 mm Outer Size: Ø 465 mm Depth: 180 mm | 5,285 | 5,790 |



| PRODUCT DESCRIPTION & DIMENSIONS | | MRP (₹) | |
|----------------------------------|---|---------|-------|
| CAT. MODEL | Features / Size | Glossy | Matt |
| RB 02 | Stainless Steel Round Basin Thickness: 1.0 mm Outer Size: Ø 470 mm Inner Size: Ø 408 mm Depth: 155 mm | 5,025 | 5,530 |



| PRODUCT DESCRIPTION & DIMENSIONS | | MRP (₹) | |
|----------------------------------|---|---------|-------|
| CAT. MODEL | Features / Size | Glossy | Matt |
| RB 03 | Stainless Steel Round Basin Thickness: 1.0 mm Outer Size: Ø 425 mm Inner Size: Ø 370 mm Depth: 165 mm | 5,025 | 5,530 |



| PRODUCT DESCRIPTION & DIMENSIONS | | MRP (₹) | |
|----------------------------------|---|---------|-------|
| CAT. MODEL | Features / Size | Glossy | Matt |
| RB 03A | Stainless Steel Round Basin Thickness: 2.5 mm Outer Size: Ø 410 mm Inner Size: Ø 370 mm Depth: 165 mm | 8,545 | 9,045 |



| PRODUCT DESCRIPTION & DIMENSIONS | | MRP (₹) | |
|----------------------------------|---|---------|-------|
| CAT. MODEL | Features / Size | Glossy | Matt |
| RB 04A | Stainless Steel Round Basin Thickness: 2.0 mm Outer Size: Ø 445 mm Depth: 140 mm | 9,405 | 9,915 |



| PRODUCT DESCRIPTION & DIMENSIONS | | MRP (₹) | |
|----------------------------------|---|---------|-------|
| CAT. MODEL | Features / Size | Glossy | Matt |
| RB 05 | Stainless Steel Round Basin Thickness: 1.0 mm Outer Size: Ø 270 mm Inner Size: Ø 250 mm Depth: 120 mm | 2,480 | 2,600 |



| PRODUCT DESCRIPTION & DIMENSIONS | | MRP (₹) | |
|----------------------------------|---|---------|-------|
| CAT. MODEL | Features / Size | Glossy | Matt |
| RB 06 | Stainless Steel Round Basin Thickness: 1.0 mm Outer Size: Ø 375 mm Inner Size: Ø 325 mm Depth: 135 mm | 3,900 | 4,410 |



| PRODUCT DESCRIPTION & DIMENSIONS | | MRP (₹) | |
|----------------------------------|----------------------|---------|--|
| CAT. MODEL | Features / Size | | |
| JS 1717 WB (With Stand) | 17 x 17 430 x 430 | 30,985 | |

*Faucet price not included in M.R.P.
Wash Basin in 3 mm thickness

PELICAN (Stainless Steel Pedestals)



| DIMENSIONS | MRP (₹) | |
|------------|---------|-------|
| | Glossy | Matt |
| CAT. MODEL | Glossy | Matt |
| PS 01 | 6,325 | 6,900 |



| DIMENSIONS | MRP (₹) | |
|------------|---------|-------|
| | Glossy | Matt |
| CAT. MODEL | Glossy | Matt |
| PS 02 | 7,520 | 8,095 |



| DIMENSIONS | MRP (₹) | |
|------------|---------|-------|
| | Glossy | Matt |
| CAT. MODEL | Glossy | Matt |
| PS 03 | 8,440 | 9,015 |



| DIMENSIONS | MRP (₹) | |
|------------|---------|-------|
| | Glossy | Matt |
| CAT. MODEL | Glossy | Matt |
| PS 04 | 9,365 | 9,950 |



| DIMENSIONS | MRP (₹) | |
|------------|---------|--------|
| | Glossy | Matt |
| CAT. MODEL | Glossy | Matt |
| PS 05 | 10,225 | 10,815 |



| DIMENSIONS | MRP (₹) | |
|------------|---------|--------|
| | Glossy | Matt |
| CAT. MODEL | Glossy | Matt |
| PS 06 | 12,380 | 12,950 |

PELICAN (Bracket Stands For Round Wash Basins)



| DIMENSIONS | MRP (₹) | |
|------------|---------|-------|
| | Glossy | Matt |
| CAT. MODEL | Glossy | Matt |
| RBS 01 | 6,200 | 6,675 |



| DIMENSIONS | MRP (₹) | |
|------------|---------|-------|
| | Glossy | Matt |
| CAT. MODEL | Glossy | Matt |
| RBS 02 | 6,200 | 6,675 |



| DIMENSIONS | MRP (₹) | |
|------------|---------|-------|
| | Glossy | Matt |
| CAT. MODEL | Glossy | Matt |
| RBS 02RR | 5,085 | 5,570 |



| DIMENSIONS | MRP (₹) | |
|------------|---------|-------|
| | Glossy | Matt |
| CAT. MODEL | Glossy | Matt |
| RBS 03 | 3,115 | 3,605 |



| DIMENSIONS | MRP (₹) | |
|------------|---------|-------|
| | Glossy | Matt |
| CAT. MODEL | Glossy | Matt |
| RBS 04 | 4,090 | 4,565 |

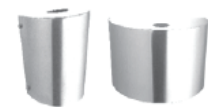

| DIMENSIONS | MRP (₹) | |
|------------|---------|-------|
| | Glossy | Matt |
| CAT. MODEL | Glossy | Matt |
| WBT 01 | 1,485 | 1,960 |
| WBT 02 | 2,250 | 2,720 |



| PRODUCT DESCRIPTION & DIMENSIONS | | MRP (₹) | |
|----------------------------------|--|---------|--------|
| CAT. MODEL | Features / Size | Glossy | Matt |
| RBGS 01 | The standard set consists of the following: 1. Stainless Steel Round Basin Size: Ø 410 x 370 mm; Depth: 165 mm; Thickness: 2.5 mm 2. Stainless Steel Pedestal with Floor mounting attachment and fittings 3. One Glass Counter (Toughened) with Stainless Steel Bracket | 23,080 | 24,950 |



| PRODUCT DESCRIPTION & DIMENSIONS | | MRP (₹) | |
|----------------------------------|--|---------|--------|
| CAT. MODEL | Features / Size | Glossy | Matt |
| RBGS 02 | The standard set consists of the following: 1. Stainless Steel Round Basin Size: Ø 410 x Ø 370 mm; Depth: 165 mm; Thickness: 2.5 mm 2. Stainless Steel Pedestal with Floor mounting attachment and fittings 3. One Glass Counter (Toughened) with Stainless Steel Bracket | 26,000 | 27,860 |



| PRODUCT DESCRIPTION & DIMENSIONS | | MRP (₹) | |
|----------------------------------|--|---------|--------|
| CAT. MODEL | Features / Size | Glossy | Matt |
| RBGS 03 | The standard set consists of the following: 1. Stainless Steel Round Basin Size: Ø 410 x Ø 370 mm; Depth: 165 mm; Thickness: 2.5 mm 2. Stainless Steel Pedestal with Floor mounting attachment and fittings 3. One Glass Counter (Toughened) with Stainless Steel Bracket | 30,700 | 32,570 |



| PRODUCT DESCRIPTION & DIMENSIONS | | MRP (₹) | |
|----------------------------------|--|---------|--------|
| CAT. MODEL | Features / Size | Glossy | Matt |
| RBGS 04 | The standard set consists of the following: 1. Stainless Steel Round Basin Size: Ø 470 x Ø 408 mm; Depth: 155 mm; Thickness: 1.0 mm 2. Stainless Steel Conical Pedestal with Floor mounting attachment and fittings 3. One Semi Round Glass Counter (Toughened with moulding) | 33,615 | 35,485 |



| PRODUCT DESCRIPTION & DIMENSIONS | | MRP (₹) | |
|----------------------------------|--|---------|--------|
| CAT. MODEL | Features / Size | Glossy | Matt |
| RBGS 05 | The standard set consists of the following: 1. Stainless Steel Round Basin Size: Ø 445 mm; Depth: 140 mm; Thickness: 2.0 mm 2. Stainless Steel Conical Pedestal with Floor mounting attachment and fittings 3. One Glass Counter (Toughened) with Stainless steel bracket | 37,595 | 39,450 |



| PRODUCT DESCRIPTION & DIMENSIONS | | MRP (₹) | |
|----------------------------------|---|---------|--------|
| CAT. MODEL | Features / Size | Glossy | Matt |
| RBPS 04 | The standard set consists of the following: 1. Stainless Steel Round Basin Size: Ø 470 x Ø 408 mm; Depth: 155 mm; Thickness: 1.0 mm 2. Stainless Steel Conical Pedestal with Floor mounting attachment and fittings | 27,960 | 29,825 |



| PRODUCT DESCRIPTION & DIMENSIONS | | MRP (₹) | |
|----------------------------------|--|---------|--------|
| CAT. MODEL | Features / Size | Glossy | Matt |
| RBPS 01 | The standard set consists of the following: 1. Stainless Steel Round Basin Size: Ø 410 x Ø 370 mm; Depth: 165 mm; Thickness: 2.5 mm 2. Stainless Steel Pedestal with Floor mounting attachment and wall mount pipe | 15,180 | 17,045 |
| RBPS 01 RR | The standard set consists of the following: 3. Stainless Steel Round Basin Size: Ø 425 x Ø 370 mm; Depth: 165 mm; Thickness: 1.0 mm 4. Stainless Steel Pedestal with Floor mounting attachment and wall mount pipe | 12,050 | 13,905 |



| PRODUCT DESCRIPTION & DIMENSIONS | | MRP (₹) | |
|----------------------------------|--|---------|--------|
| CAT. MODEL | Features / Size | Glossy | Matt |
| RBPS 02 | The standard set consists of the following: 1. Stainless Steel Round Basin Size: Ø 410 x Ø 370 mm; Depth: 165 mm; Thickness: 2.5 mm 2. Stainless Steel Conical Shaped Pedestal with Floor mounting attachment and fittings | 18,330 | 20,190 |
| RBPS 02 RR | The standard set consists of the following: 3. Stainless Steel Round Basin Size: Ø 425 x Ø 370 mm; Depth: 165 mm; Thickness: 1.0 mm 4. Stainless Steel Conical Shaped Pedestal with Floor mounting attachment and fittings | 15,110 | 16,975 |

Faucets are not a part of the standard products

COLLECTION INTERNATIONAL

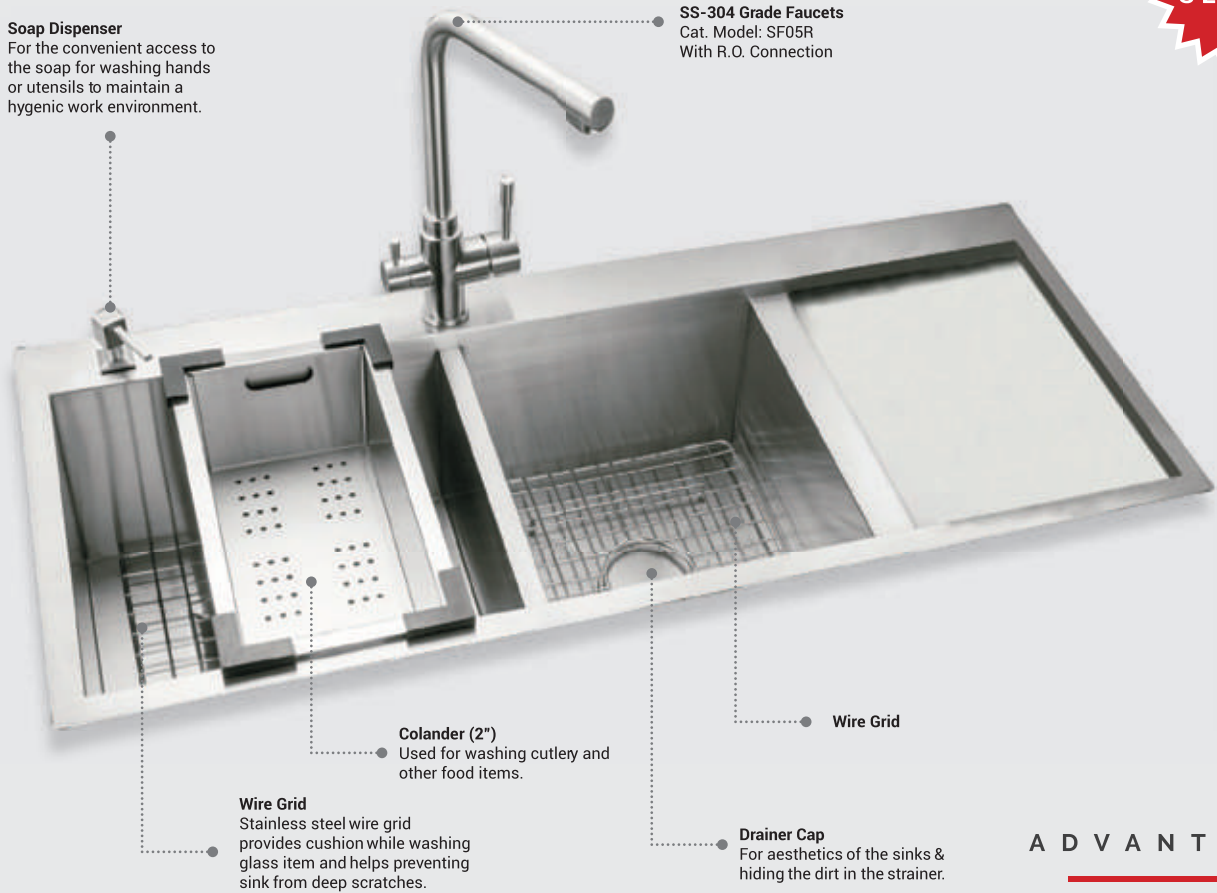

Soap Dispenser
For the convenient access to the soap for washing hands or utensils to maintain a hygienic work environment.

SS-304 Grade Faucets
Cat. Model: SF05R
With R.O. Connection

Colander (2")
Used for washing cutlery and other food items.

Wire Grid
Stainless steel wire grid provides cushion while washing glass item and helps preventing sink from deep scratches.

Drainer Cap
For aesthetics of the sinks & hiding the dirt in the strainer.

A D V A N T A G E
INGRAINED

AISI 304 | RUST PROOF | LIFETIME WARRANTY | 100% Non-Magnetic | 17.5x21.5 Models Sizes

Combo Series

We want perfection in everything we do & everything we have. Kitchen is not exception either. Jayna presents Collection International combo series of sinks with essential accessories to add health, hygiene, convenience and sophistication in your kitchen.

Features

- 1.0/1.2 mm thickness gives durability and longevity
- Unique brushed/satin finish
- Modern functional design
- International styling
- Advanced sound deadening technology
- Insect proof concentric coupling

Featuring Sink (top):
**Double Bowl Kitchen Sink with
Single Drain Board**
Cat. Model: JNS 4720T R
(1200 x 510 x 225 mm)



| | | |
|--------------------------|--|-----------------|
| Cat Model No: COMBO - 01 | | |
| Single Bowl Kitchen Sink | | |
| Cat Model: | JNS 2418 | |
| Overall Size: | 24 x 18 Inch / 610 x 460 mm | |
| Bowl Size: | 21 x 16 x 09 Inch / 550 x 400 x 225 mm | |
| Finish: | Satin | |
| Thickness: | 1.0 mm | |
| Included | Cat Model | Quantity |
| Kitchen Sink: | JNS 2418 | 1 |
| Wire Grid: | WG 02 | 1 |
| Colander (2"): | JC 02 | 1 |
| Roll Mate: | RMR 02 | 1 |
| MRP (₹) 21,450 | | |



| | | |
|--------------------------|--|-----------------|
| Cat Model No: COMBO - 02 | | |
| Single Bowl Kitchen Sink | | |
| Cat Model: | JNS 2420T | |
| Overall Size: | 24 x 20 Inch / 610 x 510 mm | |
| Bowl Size: | 21 x 16 x 09 Inch / 550 x 400 x 225 mm | |
| Finish: | Satin | |
| Thickness: | 1.0 mm | |
| Included | Cat Model | Quantity |
| Kitchen Sink: | JNS 2420T | 1 |
| Chrome Faucet: | BF 02 | 1 |
| Wire Grid: | WG 02 | 1 |
| Colander (2"): | JC 02 | 1 |
| MRP (₹) 32,305 | | |



| | | |
|----------------------------|--|-----------------|
| Cat Model No: COMBO - 03 A | | |
| Single Bowl Kitchen Sink | | |
| Cat Model: | JNS 2420T | |
| Overall Size: | 24 x 20 Inch / 610 x 510 mm | |
| Bowl Size: | 21 x 16 x 09 Inch / 550 x 400 x 225 mm | |
| Finish: | Satin | |
| Thickness: | 1.0 mm | |
| Included | Cat Model | Quantity |
| Kitchen Sink: | JNS 2420T | 1 |
| Chrome Faucet: | BF 01 | 1 |
| Wire Grid: | WG 02 | 1 |
| Colander (5"): | JS 06 | 1 |
| MRP (₹) 27,865 | | |



| | | |
|-------------------------------|--|-----------------|
| Cat Model No: COMBO - 04 | | |
| Kitchen Sink With Drain Board | | |
| Cat Model: | JNS 3618 | |
| Overall Size: | 36 x 18 Inch / 915 x 460 mm | |
| Bowl Size: | 18 x 16 x 09 Inch / 460 x 400 x 225 mm | |
| Finish: | Satin | |
| Thickness: | 1.0 mm | |
| Included | Cat Model | Quantity |
| Kitchen Sink: | JNS 3618 | 1 |
| Wire Grid: | WG 06 | 1 |
| Colander (5"): | JS 06 | 1 |
| Roll Mate: | RMR 02 | 1 |
| MRP (₹) 26,975 | | |



| | | |
|-------------------------------|--|-----------------|
| Cat Model No: COMBO - 05 | | |
| Kitchen Sink With Drain Board | | |
| Cat Model: | JNS 3620T | |
| Overall Size: | 36 x 20 Inch / 915 x 510 mm | |
| Bowl Size: | 18 x 16 x 09 Inch / 460 x 400 x 225 mm | |
| Finish: | Satin | |
| Thickness: | 1.0 mm | |
| Included | Cat Model | Quantity |
| Kitchen Sink: | JNS 3620T | 1 |
| Chrome Faucet: | BF 01 | 1 |
| Wire Grid: | WG 06 | 1 |
| Colander (2''): | JC 02 | 1 |
| Roll Mate: | RMR 02 | 1 |
| MRP (₹) 35,750 | | |



| | | |
|----------------------------|--|-----------------|
| Cat Model No: COMBO - 06 A | | |
| Double Bowl Kitchen Sink | | |
| Cat Model: | JNS 4520T DB | |
| Overall Size: | 45 x 20 Inch / 1145 x 510 mm | |
| Bowl Sizes: | 21 x 16 x 09 Inch / 527 x 400 x 225 mm | |
| | 21 x 16 x 09 Inch / 527 x 400 x 225 mm | |
| Finish: | Satin | |
| Thickness: | 1.0 mm | |
| Included | Cat Model | Quantity |
| Kitchen Sink: | JNS 4520T DB | 1 |
| Chrome Faucet: | BF 07P | 1 |
| Wire Grid: | WG 02A | 1 |
| Colander (5''): | JS 06 | 1 |
| Roll Mate: | RMR 02 | |
| MRP (₹) 51,500 | | |



| | | |
|--------------------------|--|-----------------|
| Cat Model No: COMBO - 07 | | |
| Double Bowl Kitchen Sink | | |
| Cat Model: | JNS 4520 DB | |
| Overall Size: | 45 x 20 Inch / 1145 x 510 mm | |
| Bowl Sizes: | 21 x 18 x 09 Inch / 527 x 450 x 225 mm | |
| | 21 x 18 x 09 Inch / 527 x 450 x 225 mm | |
| Finish: | Satin | |
| Thickness: | 1.0 mm | |
| Included | Cat Model | Quantity |
| Kitchen Sink: | JNS 4520 DB | 1 |
| Wire Grid: | WG 07 | 1 |
| Colander (2''): | JC 01 | 1 |
| Colander (5''): | JS 05 | 1 |
| Roll Mate: | RMR 02 | 1 |
| MRP (₹) 41,060 | | |



| | | |
|---|--|-----------------|
| Cat Model No: COMBO - 08 | | |
| Double Bowl Kitchen Sink With Drain Board | | |
| Cat Model: | JNS 4720T R | |
| Overall Size: | 47 x 20 Inch / 1200 x 510 mm | |
| Bowl Sizes: | 16 x 16 x 09 Inch / 400 x 400 x 225 mm | |
| | 14 x 16 x 09 Inch / 350 x 400 x 225 mm | |
| Finish: | Satin | |
| Thickness: | 1.0 mm | |
| Included | Cat Model | Quantity |
| Kitchen Sink: | JNS 4720T R | 1 |
| Chrome Faucet: | BF 02 | 1 |
| SS-304 Grade Faucet: | SF 08F (Faucet for RO) | 1 |
| Wire Grid: | WG 01 | 1 |
| Colander (5''): | JS 06 | 1 |
| MRP (₹) 52,270 | | |
| Combo offer also applicable for JNS 4720T L COMBO - 08A | | |



| | | |
|--|--|--|
| Cat Model No: COMBO - 09 B | | |
| Single Bowl Sink with Veg Bowl & Drain Board | | |
| Cat Model: | JD 4020 ML | |
| Overall Size: | 40 x 20 Inch / 1000 x 500 mm | |
| Bowl Sizes: | 14 x 16 x 08.5 Inch / 350 x 400 x 215 mm 07 x 12 x 05.5 Inch / 180 x 300 x 135 mm | |
| Finish: | Satin | |
| Thickness: | 1.0 mm | |
| Included | Cat Model | Quantity |
| Kitchen Sink: | JD 4020 ML | 1 |
| Chrome Faucet: | BF 05 | 1 |
| Wire Grid: | WG 04 | 1 |
| Drainer Cap: | DC 01 | 2 |
| Colander (2"): | JC 02 | 1 |
| MRP (₹) | 48,850 | Combo offer also applicable for JD 4020MR COMBO - 09 |



| | | |
|---|--|--|
| Cat Model No: COMBO - 10 A | | |
| Double Bowl Kitchen Sink With Drain Board | | |
| Cat Model: | JD 4620 L | |
| Overall Size: | 46 x 20 inch / 1160 x 500 mm | |
| Bowl Sizes: | 14 x 16 x 08.5 Inch / 350 x 400 x 215 mm 16 x 14 x 08.5 Inch / 400 x 350 x 215 mm | |
| Finish: | Satin | |
| Thickness: | 1.0 mm | |
| Included | Cat Model | Quantity |
| Kitchen Sink: | JD 4620 L | 1 |
| Chrome Faucet: | BF 07P | 1 |
| Wire Grid: | WG 04 | 1 |
| Drainer Cap: | DC 01 | 2 |
| Colander (5"): | JS 06 | 1 |
| MRP (₹) | 53,425 | Combo offer also applicable for JD 4620 R COMBO - 10 |



| | | |
|-----------------------------|--|-----------------|
| Cat Model No: COMBO - 11 | | |
| Doble Bowl Kitchen Sink | | |
| Cat Model: | JS 4520 D | |
| Overall Size: | 45 x 20 inch / 1145 x 510 mm | |
| Bowl Sizes: | 21 x 16 x 09 Inch / 530 x 400 x 225 mm | |
| Finish: | Brush | |
| Thickness: | 1.2 mm | |
| Included | Cat Model | Quantity |
| Kitchen Sink: | JS 4520 D | 1 |
| SS-304 Grade Faucet: | SF 04 | 1 |
| Wire Grid: | WG 02A | 1 |
| Drainer Cap: | DC 01 | 2 |
| Colander (5"): | JS 06 | 1 |
| Colander (2"): | JC 02 | 1 |
| MRP (₹) | 74,985 | |



| | | |
|---|--|---|
| Cat Model No: COMBO - 12 A | | |
| Double Bowl Kitchen Sink With Drain Board | | |
| Cat Model: | JS 4520 R | |
| Overall Size: | 45 x 20 inch / 1145 x 510 mm | |
| Bowl Sizes: | 13 x 16 x 09 Inch / 340 x 400 x 225 mm 16 x 16 x 09 Inch / 400 x 400 x 225 mm | |
| Finish: | Brush | |
| Thickness: | 1.2 mm | |
| Included | Cat Model | Quantity |
| Kitchen Sink: | JS 4520 R | 1 |
| Chrome Faucet: | BF 07P | 1 |
| Wire Grid: | WG 01 | 1 |
| Drainer Cap: | DC 01 | 2 |
| Colander (2"): | JC 02 | 1 |
| Roll Mate: | RMS 01 | 1 |
| MRP (₹) | 69,900 | Combo offer also applicable for JS 4520 L COMBO - 12A |



ADVANTAGE
INGRAINED

PVD Square Series

The sink is the centre piece of your kitchen sink and a colourful sink will light up your kitchen like a diamond.

Physical vapour deposition (PVD) is an innovative technology that allows deposition of a very fine colour film on the stainless steel kitchen sinks which is not only aesthetic in look and showcases luxury in your kitchen space but also a very durable and 100% suitable for use in contact with food.

Features:

- 1.2mm thickness stainless steel gives durability & longevity.
- Aesthetic PVD coloured look of your choice
- International Styling
- Anti-Bacterial

AISI 304 | RUST PROOF | 145x215 | PVD



| CAT. MODEL | Overall Size (inch/mm) | Bowl Size (inch/mm) | DIMENSIONS | | | |
|------------|---------------------------------|---------------------------------|------------|-----------|--------|--------|
| | | | Gold | Rose Gold | Grey | Black |
| JSPV 2418 | 24 x 18 x 09 610 x 460 x 225 | 22 x 16 x 09 560 x 400 x 225 | 36,500 | 36,500 | 38,500 | 38,500 |



| CAT. MODEL | Overall Size (inch/mm) | Bowl Size (inch/mm) | DIMENSIONS | | | |
|------------|---------------------------------|---------------------------------|------------|-----------|--------|--------|
| | | | Gold | Rose Gold | Grey | Black |
| JSPV 2420T | 24 x 20 x 09 610 x 510 x 225 | 22 x 16 x 09 560 x 400 x 225 | 40,500 | 40,500 | 42,500 | 42,500 |



| CAT. MODEL | Overall Size (inch/mm) | Bowl Size (inch/mm) | DIMENSIONS | | | |
|-----------------|----------------------------------|--|------------|-----------|--------|--------|
| | | | Gold | Rose Gold | Grey | Black |
| JSPV 4520 DT | 45 x 20 x 09 1145 x 510 x 225 | 1st Bowl 21 x 16 x 09 530 x 400 x 225 2nd Bowl 21 x 16 x 09 530 x 400 x 225 | 63,700 | 63,700 | 65,700 | 65,700 |

Colour Available —



Gold



Rose Gold



Grey



Black



Regal PVD Square Series

The sink is the centre piece of your kitchen sink and a colourful sink will light up your kitchen like a diamond.

Physical vapour deposition (PVD) is an innovative technology that allows deposition of a very fine colour film on the stainless steel kitchen sinks which is not only aesthetic in look and showcases luxury in your kitchen space but also a very durable and 100% suitable for use in contact with food.

Features:

- 1mm thickness stainless steel gives durability & longevity.
- Aesthetic PVD coloured look of your choice
- International Styling
- Anti-Bacterial

Colour Available



Gold



Black

AISI 304 | RUST PROOF | 145x215 | PVD



| DIMENSIONS | | | | |
|------------|---------------------------------|---------------------------------|--------|--------|
| CAT. MODEL | Overall Size (inch/mm) | Bowl Size (inch/mm) | Gold | Black |
| JRPV 2418 | 24 x 18 x 09 610 x 460 x 225 | 22 x 16 x 09 560 x 400 x 225 | 26,300 | 26,300 |



| DIMENSIONS | | | | |
|------------|---------------------------------|---------------------------------|--------|--------|
| CAT. MODEL | Overall Size (inch/mm) | Bowl Size (inch/mm) | Gold | Black |
| JRPV 2420T | 24 x 20 x 09 610 x 510 x 225 | 21 x 16 x 09 550 x 400 x 225 | 30,100 | 30,100 |

Accessories Included: Soap dispenser



| DIMENSIONS | | | | |
|--------------|---------------------------------|--|--------|--------|
| CAT. MODEL | Overall Size (inch/mm) | Bowl Size (inch/mm) | Gold | Black |
| JRPV 3718 DB | 37 x 18 x 09 940 x 460 x 225 | 1st Bowl 17 x 16 x 09 425 x 400 x 225 2nd Bowl 17 x 16 x 09 425 x 400 x 225 | 42,500 | 42,500 |



| DIMENSIONS | | | | |
|--------------|----------------------------------|--|--------|--------|
| CAT. MODEL | Overall Size (inch/mm) | Bowl Size (inch/mm) | Gold | Black |
| JRPV 4520 DB | 45 x 20 x 09 1145 x 510 x 225 | 1st Bowl 21 x 18 x 09 528 x 450 x 225 2nd Bowl 21 x 18 x 09 528 x 450 x 225 | 50,200 | 50,200 |



| DIMENSIONS | | | | |
|--------------|----------------------------------|--|--------|--------|
| CAT. MODEL | Overall Size (inch/mm) | Bowl Size (inch/mm) | Gold | Black |
| JRPV 4520 DT | 45 x 20 x 09 1145 x 510 x 225 | 1st Bowl 21 x 16 x 09 528 x 400 x 225 2nd Bowl 21 x 16 x 09 528 x 400 x 225 | 54,800 | 54,800 |

Accessories Included: Soap dispenser



Noble Square Series

Crafted from High Grade AISI-304 (18/8) - 18% Chrome, 8% Nickel in 1.0 mm thickness. Smart feature, excellent luster, maximum durability and strength 100% hygienic.

Features —

- 1.0 mm thickness gives durability and longevity
- Unique satin finish
- Modern functional design
- International styling
- Advanced sound deadening technology
- Insect proof concentric coupling

AISI 304 | RUST PROOF | LIFETIME WARRANTY | 100% Non-Magnetic | 145x215 Models Sizes



| DIMENSIONS | | | MRP (₹) |
|------------|---------------------------------|---------------------------------|---------|
| CAT. MODEL | Overall Size (inch/mm) | Bowl Size (inch/mm) | |
| JNS 1218 | 12 x 18 x 08 305 x 450 x 200 | 10 x 16 x 08 255 x 400 x 200 | 7,405 |

| OPTIONAL ACCESSORIES | |
|----------------------|----------|
| Wire Grid | Colander |
| - | - |



| DIMENSIONS | | | MRP (₹) |
|------------|---------------------------------|---------------------------------|---------|
| CAT. MODEL | Overall Size (inch/mm) | Bowl Size (inch/mm) | |
| JNS 1518 | 15x 18 x 08 380 x 450 x 200 | 13 x 16 x 08 330 x 400 x 200 | 9,890 |
| JNS 1616 | 16 x 16 x 08 400 x 400 x 200 | 14 x 14 x 08 350 x 350 x 200 | 9,890 |

| OPTIONAL ACCESSORIES | |
|----------------------|----------|
| Wire Grid | Colander |
| - | JS 06 |
| - | - |



| DIMENSIONS | | | MRP (₹) |
|------------|---------------------------------|---------------------------------|---------|
| CAT. MODEL | Overall Size (inch/mm) | Bowl Size (inch/mm) | |
| JNS 1816 | 18 x 16 x 08 450 x 400 x 200 | 16 x 14 x 08 400 x 350 x 200 | 9,790 |
| JNS 1918 | 19 x 18 x 08 480 x 450 x 200 | 17 x 16 x 08 430 x 400 x 200 | 10,720 |
| JNS 2118 | 21 x 18 x 09 530 x 450 x 225 | 19 x 16 x 09 480 x 400 x 225 | 11,085 |
| JNS 2418 | 24 x 18 x 09 610 x 460 x 225 | 21 x 16 x 09 550 x 400 x 225 | 12,495 |
| JNS 2420 | 24 x 20 x 09 610 x 510 x 225 | 21 x 18 x 09 550 x 450 x 225 | 13,670 |

| OPTIONAL ACCESSORIES | |
|----------------------|------------------------|
| Wire Grid | Colander |
| WG 04 | JC 04 / JS 07A / JR 01 |
| - | JC 02 / JS 06 / JR 02 |
| WG 06 | JC 02 / JS 06 / JR 02 |
| WG 02 | JC 02 |
| - | JC 01 / JS 05 / JR 03 |



| DIMENSIONS | | | MRP (₹) |
|----------------------|---------------------------------|---------------------------------|---------|
| CAT. MODEL | Overall Size (inch/mm) | Bowl Size (inch/mm) | |
| JNS 1719T (Bar Sink) | 17 x 19 x 08 430 x 485 x 200 | 15 x 15 x 08 380 x 380 x 200 | 11,490 |
| JNS 2420T | 24 x 20 x 09 610 x 510 x 225 | 21 x 16 x 09 550 x 400 x 225 | 15,040 |
| JNS 3220T | 32 x 20 x 09 810 x 510 x 225 | 29 x 16 x 09 750 x 400 x 225 | 19,190 |

| OPTIONAL ACCESSORIES | |
|----------------------|-----------------------|
| Wire Grid | Colander |
| - | - |
| WG 02 | JC 02 / JS 06 / JR 02 |
| - | JC 02 / JS 06 / JR 02 |



| DIMENSIONS | | | MRP (₹) |
|------------|---------------------------------|-----------------------------------|---------|
| CAT. MODEL | Overall Size (inch/mm) | Bowl Size (inch/mm) | |
| JNS 3018 | 30 x 18 x 09 760 x 460 x 225 | 27 x 16 x 09 700 x 400 x 225 | 17,695 |
| JNS 3220 | 32 x 20 x 09 810 x 510 x 225 | 29.5 x 18 x 09 750 x 450 x 225 | 18,200 |

| OPTIONAL ACCESSORIES | |
|----------------------|-----------------------|
| Wire Grid | Colander |
| - | JC 02 |
| - | JC 01 / JS 05 / JR 03 |



| DIMENSIONS | | | MRP (₹) |
|------------|---------------------------------|--|---------|
| CAT. MODEL | Overall Size (inch/mm) | Bowl Size (inch/mm) | |
| JNS 2420 D | 24 x 20 x 09 610 x 510 x 225 | 1st Bowl: 07 x 16 x 06 180 x 400 x 150 2nd Bowl: 13 x 16 x 09 340 x 400 x 225 | 20,005 |

| OPTIONAL ACCESSORIES | |
|----------------------|-----------------------|
| Wire Grid | Colander |
| - | JC 02 / JS 06 / JR 02 |

NOBLE SQUARE SERIES R-0 Sinks With 1.0 mm Thickness, Zero Radius & Satin Finish



| DIMENSIONS | | | MRP (₹) |
|------------|----------------------------------|---------------------------------|---------|
| CAT. MODEL | Overall Size (inch/mm) | Bowl Size (inch/mm) | |
| JNS 3618 | 36 x 18 x 09 915 x 460 x 225 | 18 x 16 x 09 460 x 400 x 225 | 17,410 |
| JNS 3620 | 36 x 20 x 09 915 x 510 x 225 | 18 x 18 x 09 460 x 460 x 225 | 19,190 |
| JNS 4018 | 40 x 18 x 09 1000 x 460 x 225 | 20 x 16 x 09 510 x 400 x 225 | 19,780 |
| JNS 4120 | 41 x 20 x 09 1040 x 510 x 225 | 18 x 18 x 09 460 x 450 x 225 | 20,700 |
| JNS 4520 | 45 x 20 x 09 1145 x 510 x 225 | 22 x 18 x 09 560 x 460 x 225 | 23,990 |

| OPTIONAL ACCESSORIES | |
|----------------------|-----------------------|
| Wire Grid | Colander |
| WG 06 | JC 02 / JS 06 / JR 02 |
| - | JC 01 / JS 05 |
| - | JC 02 / JS 06 / JR 02 |
| - | JC 01 / JS 05/ JR 03 |



| DIMENSIONS | | | MRP (₹) |
|------------|----------------------------------|---------------------------------|---------|
| CAT. MODEL | Overall Size (inch/mm) | Bowl Size (inch/mm) | |
| JNS 3620T | 36 x 20 x 09 915 x 510 x 225 | 18 x 16 x 09 460 x 400 x 225 | 20,730 |
| JNS 4520T | 45 x 20 x 09 1145 x 510 x 225 | 22 x 16 x 09 560 x 400 x 225 | 25,940 |

| OPTIONAL ACCESSORIES | |
|----------------------|-----------------------|
| Wire Grid | Colander |
| WG 06 | JC 02 / JS 06 / JR 02 |

Available in LHD/RHD



| DIMENSIONS | | | | MRP (₹) |
|------------|----------------------------------|---------------------|---------------------------------|---------|
| CAT. MODEL | Overall Size (inch/mm) | Bowl Size (inch/mm) | | |
| JNS 3118DB | 31 x 18 x 09 790 x 460 x 225 | 1st Bowl | 14 x 16 x 09 350 x 400 x 225 | 17,500 |
| | | 2nd Bowl | 14 x 16 x 09 350 x 400 x 225 | |
| JNS 3420DB | 34 x 20 x 09 865 x 510 x 225 | 1st Bowl | 15 x 18 x 09 375 x 450 x 225 | 21,800 |
| | | 2nd Bowl | 16 x 18 x 09 400 x 450 x 225 | |
| JNS 3718DB | 37 x 18 x 09 940 x 460 x 225 | 1st Bowl | 18 x 16 x 09 450 x 400 x 225 | 23,110 |
| | | 2nd Bowl | 16 x 16 x 09 400 x 400 x 225 | |
| JNS 4218DB | 42 x 18 x 09 1070 x 460 x 225 | 1st Bowl | 21 x 16 x 09 525 x 400 x 225 | 26,040 |
| | | 2nd Bowl | 18 x 16 x 09 455 x 400 x 225 | |
| JNS 4518DB | 45 x 18 x 09 1145 x 460 x 225 | 1st Bowl | 21 x 16 x 09 527 x 400 x 225 | 27,185 |
| | | 2nd Bowl | 21 x 16 x 09 527 x 400 x 225 | |
| JNS 4520DB | 45 x 20 x 09 1145 x 510 x 225 | 1st Bowl | 21 x 18 x 09 527 x 450 x 225 | 28,265 |
| | | 2nd Bowl | 21 x 18 x 09 527 x 450 x 225 | |

| OPTIONAL ACCESSORIES | |
|----------------------|-----------------------|
| Wire Grid | Colander |
| WG 04 | JC 02 / JS 06 / JR 02 |

| | |
|---|-----------------------|
| - | JC 01 / JS 05 / JR 03 |
|---|-----------------------|

| | |
|-------------|-----------------------|
| WG 01/WG 06 | JC 02 / JS 06 / JR 02 |
|-------------|-----------------------|

| | |
|-------|-----------------------|
| WG 06 | JC 02 / JS 06 / JR 02 |
|-------|-----------------------|

| | |
|--------|-----------------------|
| WG 02A | JC 02 / JS 06 / JR 02 |
|--------|-----------------------|

| | |
|-------|-----------------------|
| WG 07 | JC 01 / JS 05 / JR 03 |
|-------|-----------------------|



| DIMENSIONS | | | | MRP (₹) |
|--------------|----------------------------------|---------------------|---------------------------------|---------|
| CAT. MODEL | Overall Size (inch/mm) | Bowl Size (inch/mm) | | |
| JNS 3520T DB | 35 x 20 x 09 890 x 510 x 225 | 1st Bowl | 16 x 16 x 09 400 x 400 x 225 | 24,045 |
| | | 2nd Bowl | 16 x 16 x 09 400 x 400 x 225 | |
| JNS 3720T DB | 37 x 20 x 09 940 x 510 x 225 | 1st Bowl | 18 x 16 x 09 450 x 400 x 225 | 25,220 |
| | | 2nd Bowl | 16 x 16 x 09 400 x 400 x 225 | |
| JNS 4220T DB | 42 x 20 x 09 1070 x 510 x 225 | 1st Bowl | 21 x 16 x 09 527 x 400 x 225 | 27,565 |
| | | 2nd Bowl | 18 x 16 x 09 450 x 400 x 225 | |
| JNS 4520T DB | 45 x 20 x 09 1145 x 510 x 225 | 1st Bowl | 21 x 16 x 09 527 x 400 x 225 | 29,910 |
| | | 2nd Bowl | 21 x 16 x 09 527 x 400 x 225 | |

| OPTIONAL ACCESSORIES | |
|----------------------|-----------------------|
| Wire Grid | Colander |
| WG 01 | JC 02 / JS 06 / JR 02 |

| | |
|-------------|-----------------------|
| WG 06/WG 01 | JC 02 / JS 06 / JR 02 |
|-------------|-----------------------|

| | |
|--------------|-----------------------|
| WG 02A/WG 06 | JC 02 / JS 06 / JR 02 |
|--------------|-----------------------|

| | |
|--------|-----------------------|
| WG 02A | JC 02 / JS 06 / JR 02 |
|--------|-----------------------|



| CAT. MODEL | DIMENSIONS | | | MRP (₹) |
|---------------|---------------------------------|----------|---------------------------------------|-----------|
| | Overall Size (inch/mm) | | Bowl Size (inch/mm) | |
| JNS 3118 TDBN | 31 x 18 x 09 780 x 460 x 225 | 1st Bowl | 15 x 16 x 09 380 x 400 x 225 | 18,200 |
| | | 2nd Bowl | 12.25 x 13.75 x 09 310 x 350 x 225 | |
| JNS 3420 TDBN | 34 x 20 x 09 865 x 510 x 225 | 1st Bowl | 16 x 18 x 09 400 x 450 x 225 | 22,700 |
| | | 2nd Bowl | 15 x 16 x 09 375 x 400 x 225 | |

| OPTIONAL ACCESSORIES | |
|----------------------|-----------------------|
| Wire Grid | Colander |
| WG 01 | JC 02 / JS 06 / JR 02 |
| WG 06 | JC 01 / JS 05 / JR 03 |



| CAT. MODEL | DIMENSIONS | | | MRP (₹) |
|---------------|----------------------------------|----------|-----------------------------------|-----------|
| | Overall Size (inch/mm) | | Bowl Size (inch/mm) | |
| JNS 3720 TDBN | 37 x 20 x 09 740 x 510 x 225 | 1st Bowl | 18 x 18 x 09 450 x 450 x 225 | 25,850 |
| | | 2nd Bowl | 16 x 16 x 09 400 x 400 x 225 | |
| JNS 4220 TDBN | 42 x 20 x 09 1070 x 510 x 225 | 1st Bowl | 21 x 18 x 09 525 x 450 x 225 | 28,200 |
| | | 2nd Bowl | 18 x 16 x 09 460 x 400 x 225 | |
| JNS 4520 TDBN | 45 x 20 x 09 1145 x 510 x 225 | 1st Bowl | 22.5 x 18 x 09 570 x 450 x 225 | 30,500 |
| | | 2nd Bowl | 19 x 16 x 09 480 x 400 x 225 | |

| OPTIONAL ACCESSORIES | |
|----------------------|-----------------------|
| Wire Grid | Colander |
| WG 01 | JC 01 / JS 05 / JR 03 |
| WG 06 | JC 01 / JS 05 / JR 03 |
| | JC 01 / JS 05 / JR 03 |



| CAT. MODEL | DIMENSIONS | | | MRP (₹) |
|------------|----------------------------------|----------|-----------------------------------|-----------|
| | Overall Size (inch/mm) | | Bowl Size (inch/mm) | |
| JNS 4618 | 46 x 18 x 09 1160 x 460 x 225 | 1st Bowl | 16 x 16 x 09 400 x 400 x 225 | 26,980 |
| | | 2nd Bowl | 14 x 16 x 09 350 x 400 x 225 | |
| JNS 6120 | 61 x 20 x 09 1550 x 510 x 225 | 1st Bowl | 18 x 17.7 x 09 460 x 450 x 225 | 39,680 |
| | | 2nd Bowl | 18 x 17.7 x 09 460 x 450 x 225 | |

| OPTIONAL ACCESSORIES | |
|----------------------|-----------------------|
| Wire Grid | Colander |
| WG 01 | JC 02 / JS 06 / JR 02 |



| CAT. MODEL | DIMENSIONS | | | MRP (₹) |
|-------------|----------------------------------|----------|---------------------------------|-----------|
| | Overall Size (inch/mm) | | Bowl Size (inch/mm) | |
| JNS 4720T R | 47 x 20 x 09 1200 x 510 x 225 | 1st Bowl | 16 x 16 x 09 400 x 400 x 225 | 30,205 |
| | | 2nd Bowl | 14 x 16 x 09 350 x 400 x 225 | |
| JNS 4720T L | 47 x 20 x 09 1200 x 510 x 225 | 1st Bowl | 16 x 16 x 09 400 x 400 x 225 | 30,205 |
| | | 2nd Bowl | 14 x 16 x 09 350 x 400 x 225 | |

| OPTIONAL ACCESSORIES | |
|----------------------|-----------------------|
| Wire Grid | Colander |
| WG 01 | JC 02 / JS 06 / JR 02 |
| WG 01 | JC 02 / JS 06 / JR 02 |



| CAT. MODEL | DIMENSIONS | | | MRP (₹) |
|------------|-------------------------------------|--|---------------------------------|-----------|
| | Overall Size (inch/mm) | | Bowl Size (inch/mm) | |
| JNS CS 01 | 24.5 x 24.5 x 09 620 x 620 x 225 | | 14 x 14 x 09 340 x 340 x 225 | 22,500 |
| JNS CS 02 | 27 x 27 x 09 680 x 680 x 225 | | 16 x 16 x 09 400 x 400 x 225 | 25,500 |

| OPTIONAL ACCESSORIES | |
|----------------------|----------|
| Wire Grid | Colander |
| - | - |
| - | - |

• Optional customisation of any size possible on request



Regal Series

Sink with micro radius technology. Crafted from High Grade AISI-304 (18/8) - 18% Chrome, 8% Nickel in 1.0 mm thickness. Smart feature, excellent luster, maximum durability and strength 100% hygienic.

Features

- 1.0 mm thickness gives durability and longevity
- Unique satin finish
- Modern functional design
- International styling
- Advanced sound deadening technology
- Insect proof concentric coupling

AISI 304 | RUST PROOF | LIFETIME WARRANTY | 100% Non-Magnetic | 145x215 Models Sizes



| DIMENSIONS | | | MRP (₹) |
|------------|---------------------------------|---------------------------------|-----------|
| CAT. MODEL | Overall Size (inch/mm) | Bowl Size (inch/mm) | |
| JNRS 1816 | 18 x 16 x 08 450 x 400 x 200 | 16 x 14 x 08 400 x 350 x 200 | 10,840 |
| JNRS 2118 | 21 x 18 x 09 530 x 450 x 225 | 19 x 16 x 09 480 x 400 x 225 | 12,145 |
| JNRS 2418 | 24 x 18 x 09 610 x 460 x 225 | 21 x 16 x 09 550 x 400 x 225 | 13,725 |

| OPTIONAL ACCESSORIES | |
|----------------------|------------------------|
| Wire Grid | Colander |
| WGN 01 | JC 04 / JS 07A / JR 01 |
| WGN 02 | JC 02 / JS 06 / JR 02 |
| WGN 03 | JC 02 / JS 06 / JR 02 |



| DIMENSIONS | | | MRP (₹) |
|------------|---------------------------------|---------------------------------|-----------|
| CAT. MODEL | Overall Size (inch/mm) | Bowl Size (inch/mm) | |
| JNRS 2420T | 24 x 20 x 09 610 x 510 x 225 | 21 x 16 x 09 550 x 400 x 225 | 16,305 |

| OPTIONAL ACCESSORIES | |
|----------------------|-----------------------|
| Wire Grid | Colander |
| WGN 03 | JC 02 / JS 06 / JR 02 |



| DIMENSIONS | | | MRP (₹) |
|------------|---------------------------------|---------------------------------|-----------|
| CAT. MODEL | Overall Size (inch/mm) | Bowl Size (inch/mm) | |
| JNRS 3618 | 36 x 18 x 09 915 x 460 x 225 | 18 x 16 x 09 460 x 400 x 225 | 18,210 |

| OPTIONAL ACCESSORIES | |
|----------------------|-----------------------|
| Wire Grid | Colander |
| WGN 06 | JC 02 / JS 06 / JR 02 |



| DIMENSIONS | | | | MRP (₹) |
|-------------|---------------------------------|---------------------|---------------------------------|-----------|
| CAT. MODEL | Overall Size (inch/mm) | Bowl Size (inch/mm) | | |
| JNRS 3718DB | 37 x 18 x 09 940 x 460 x 225 | 1st Bowl | 18 x 16 x 09 450 x 400 x 225 | 25,690 |

| OPTIONAL ACCESSORIES | |
|----------------------|-----------------------|
| Wire Grid | Colander |
| WGN 08 | JC 02 / JS 06 / JR 02 |

| | | | | |
|--|--|----------|---------------------------------|--|
| | | 2nd Bowl | 16 x 16 x 09 400 x 400 x 225 | |
|--|--|----------|---------------------------------|--|

| | | | | |
|-------------|----------------------------------|----------|---------------------------------|--------|
| JNRS 4218DB | 42 x 18 x 09 1070 x 460 x 225 | 1st Bowl | 21 x 16 x 09 525 x 400 x 225 | 28,625 |
|-------------|----------------------------------|----------|---------------------------------|--------|

| | |
|--------|-----------------------|
| WGN 09 | JC 02 / JS 06 / JR 02 |
|--------|-----------------------|

| | | | | |
|--|--|----------|---------------------------------|--|
| | | 2nd Bowl | 18 x 16 x 09 455 x 400 x 225 | |
|--|--|----------|---------------------------------|--|

| | | | | |
|--------------|----------------------------------|----------|---------------------------------|--------|
| JNRS 4518 DB | 45 x 18 x 09 1145 x 460 x 225 | 1st Bowl | 21 x 16 x 09 527 x 400 x 225 | 31,085 |
|--------------|----------------------------------|----------|---------------------------------|--------|

| | |
|--------|-----------------------|
| WGN 09 | JC 02 / JS 06 / JR 02 |
|--------|-----------------------|

| | | | | |
|--|--|----------|---------------------------------|--|
| | | 2nd Bowl | 21 x 16 x 09 527 x 400 x 225 | |
|--|--|----------|---------------------------------|--|

| | | | | |
|-------------|----------------------------------|----------|---------------------------------|--------|
| JNRS 4520DB | 45 x 20 x 09 1145 x 510 x 225 | 1st Bowl | 21 x 18 x 09 527 x 450 x 225 | 29,500 |
|-------------|----------------------------------|----------|---------------------------------|--------|

| | |
|--------|-----------------------|
| WGN 07 | JC 01 / JS 05 / JR 03 |
|--------|-----------------------|

| | | | | |
|--|--|----------|---------------------------------|--|
| | | 2nd Bowl | 21 x 18 x 09 527 x 450 x 225 | |
|--|--|----------|---------------------------------|--|



| DIMENSIONS | | | | MRP (₹) |
|----------------|----------------------------------|---------------------|---------------------------------|-----------|
| CAT. MODEL | Overall Size (inch/mm) | Bowl Size (inch/mm) | | |
| JNRS 4520 T DB | 45 x 20 x 09 1145 x 510 x 225 | 1st Bowl | 21 x 16 x 09 527 x 400 x 225 | 33,430 |
| | | 2nd Bowl | 21 x 16 x 09 527 x 400 x 225 | |

| OPTIONAL ACCESSORIES | |
|----------------------|-----------------------|
| Wire Grid | Colander |
| WGN 09 | JC 02 / JS 06 / JR 02 |

• Optional customisation of any size possible on request

Reference page no 52 & 53



Featuring Sink (top):
JS 4520 R
(1160 x 510 x 225 mm)

Square Series

In today's hectic world, people yearn more and more for tranquility and simplicity. Jayna focuses on the basics: the enjoyment of your time in kitchen. There are no distractions. Behold a collection that will never go out of fashion. Surrender to happiness unbounded...

Features —

- 1.2 mm thickness gives durability and longevity
- Unique brushed/satin finish
- Modern functional design
- International styling
- Advanced sound deadening technology
- Insect proof concentric coupling

AISI 304 | RUST PROOF | LIFETIME WARRANTY | 100% Non-Magnetic | 145x215 Models Sizes



| DIMENSIONS | | | |
|--------------------|---------------------------------|---------------------------------|--------------|
| CAT. MODEL | Overall Size (inch/mm) | Bowl Size (inch/mm) | Cabinet Size |
| JS 1820 (Bar Sink) | 18 x 20 x 09 460 x 510 x 225 | 16 x 16 x 09 400 x 400 x 225 | 45 cm |
| MRP (₹) | 18,605 | | |

| OPTIONAL ACCESSORIES | |
|----------------------|-----------------------|
| Wire Grid | Colander |
| WG 01 | JC 02 / JS 06 / JR 02 |



| DIMENSIONS | | | |
|----------------|---------------------------------|---------------------------------|--------------|
| CAT. MODEL | Overall Size (inch/mm) | Bowl Size (inch/mm) | Cabinet Size |
| JS 2418 | 24 x 18 x 09 610 x 460 x 225 | 22 x 16 x 09 550 x 400 x 225 | 60 cm |
| MRP (₹) | 23,675 | | |

| OPTIONAL ACCESSORIES | |
|----------------------|-----------------------|
| Wire Grid | Colander |
| WG 02 | JC 02 / JS 06 / JR 02 |



| DIMENSIONS | | | |
|----------------|---------------------------------|---------------------------------|--------------|
| CAT. MODEL | Overall Size (inch/mm) | Bowl Size (inch/mm) | Cabinet Size |
| JS 2420 | 24 x 20 x 09 610 x 510 x 225 | 22 x 16 x 09 550 x 400 x 225 | 60 cm |
| MRP (₹) | 26,185 | | |

| OPTIONAL ACCESSORIES | |
|----------------------|-----------------------|
| Wire Grid | Colander |
| WG 02 | JC 02 / JS 06 / JR 02 |



| DIMENSIONS | | | |
|----------------|---------------------------------|-----------------------------------|--------------|
| CAT. MODEL | Overall Size (inch/mm) | Bowl Size (inch/mm) | Cabinet Size |
| JS 3020 | 30 x 20 x 09 760 x 510 x 225 | 27.5 x 15 x 09 700 x 400 x 225 | 75 cm |
| MRP (₹) | 29,810 | | |

| OPTIONAL ACCESSORIES | |
|----------------------|-----------------------|
| Wire Grid | Colander |
| - | JC 02 / JS 06 / JR 02 |



| DIMENSIONS | | | |
|----------------|---------------------------------|---------------------------------|--------------|
| CAT. MODEL | Overall Size (inch/mm) | Bowl Size (inch/mm) | Cabinet Size |
| JS 3218 | 32 x 18 x 09 810 x 460 x 225 | 30 x 16 x 09 750 x 400 x 225 | 80 cm |
| MRP (₹) | 27,575 | | |

| OPTIONAL ACCESSORIES | |
|----------------------|-----------------------|
| Wire Grid | Colander |
| - | JC 02 / JS 06 / JR 02 |



| DIMENSIONS | | | |
|----------------|---------------------------------|--|--------------|
| CAT. MODEL | Overall Size (inch/mm) | Bowl Size (inch/mm) | Cabinet Size |
| JS 3418 D | 34 x 18 x 09 865 x 460 x 225 | 1st Bowl 14 x 16 x 09 380 x 400 x 225 2nd Bowl 16 x 16 x 09 400 x 400 x 225 | 90 cm |
| MRP (₹) | 35,225 | | |

| OPTIONAL ACCESSORIES | |
|----------------------|-----------------------|
| Wire Grid | Colander |
| WG 01 | JC 02 / JS 06 / JR 02 |



| DIMENSIONS | | | |
|----------------|----------------------------------|---------------------|---------------------------------|
| CAT. MODEL | Overall Size (inch/mm) | Bowl Size (inch/mm) | Cabinet Size |
| JS 4520 D | 45 x 20 x 09 1145 x 510 x 225 | 1st Bowl | 21 x 16 x 09 530 x 400 x 225 |
| | | 2nd Bowl | 21 x 16 x 09 530 x 400 x 225 |
| | | | |
| MRP (₹) | 48,615 | | |

| OPTIONAL ACCESSORIES | |
|----------------------|-----------------------|
| Wire Grid | Colander |
| WG 02A | JC 02 / JS 06 / JR 02 |



| DIMENSIONS | | | |
|----------------|---------------------------------|---------------------------------|--------------|
| CAT. MODEL | Overall Size (inch/mm) | Bowl Size (inch/mm) | Cabinet Size |
| JS 3120 AR | 31 x 20 x 09 780 x 510 x 225 | 13 x 16 x 09 340 x 400 x 225 | 40 cm |
| MRP (₹) | 19,500 | | |

| OPTIONAL ACCESSORIES | |
|----------------------|-----------------------|
| Wire Grid | Colander |
| WG 04 | JC 02 / JS 06 / JR 02 |



| DIMENSIONS | | | |
|----------------|---------------------------------|---------------------------------|--------------|
| CAT. MODEL | Overall Size (inch/mm) | Bowl Size (inch/mm) | Cabinet Size |
| JS 3120 AL | 31 x 20 x 09 780 x 510 x 225 | 13 x 16 x 09 340 x 400 x 225 | 40 cm |
| MRP (₹) | 19,500 | | |

| OPTIONAL ACCESSORIES | |
|----------------------|-----------------------|
| Wire Grid | Colander |
| WG 04 | JC 02 / JS 06 / JR 02 |



| DIMENSIONS | | | |
|----------------|---------------------------------|---------------------------------|--------------|
| CAT. MODEL | Overall Size (inch/mm) | Bowl Size (inch/mm) | Cabinet Size |
| JS 3720 | 37 x 20 x 09 940 x 510 x 225 | 18 x 18 x 09 450 x 450 x 225 | 50 cm |
| MRP (₹) | 27,575 | | |

| OPTIONAL ACCESSORIES | |
|----------------------|-----------------------|
| Wire Grid | Colander |
| - | JC 01 / JS 05 / JR 03 |



| DIMENSIONS | | | |
|----------------|------------------------------------|---------------------|---------------------------------|
| CAT. MODEL | Overall Size (inch/mm) | Bowl Size (inch/mm) | Cabinet Size |
| JS 4018 M | 39.5 x 18 x 09 1000 x 460 x 225 | 1st Bowl | 16 x 16 x 09 400 x 400 x 225 |
| | | 2nd Bowl | 07 x 16 x 06 180 x 400 x 150 |
| | | | |
| MRP (₹) | 38,720 | | |

| OPTIONAL ACCESSORIES | |
|----------------------|-----------------------|
| Wire Grid | Colander |
| WG 01 | JC 02 / JS 06 / JR 02 |



| DIMENSIONS | | | |
|----------------|----------------------------------|---------------------|---------------------------------|
| CAT. MODEL | Overall Size (inch/mm) | Bowl Size (inch/mm) | Cabinet Size |
| JS 4020 MR | 40 x 20 x 09 1000 x 510 x 225 | 1st Bowl | 16 x 16 x 09 400 x 400 x 225 |
| | | 2nd Bowl | 07 x 16 x 06 180 x 410 x 150 |
| | | | |
| MRP (₹) | 44,015 | | |

| OPTIONAL ACCESSORIES | |
|----------------------|-----------------------|
| Wire Grid | Colander |
| WG 01 | JC 02 / JS 06 / JR 02 |



| DIMENSIONS | | | |
|----------------|----------------------------------|---------------------|---------------------------------|
| CAT. MODEL | Overall Size (inch/mm) | Bowl Size (inch/mm) | Cabinet Size |
| JS 4020 ML | 40 x 20 x 09 1000 x 510 x 225 | 1st Bowl | 07 x 16 x 06 180 x 410 x 150 |
| | | 2nd Bowl | 16 x 16 x 09 400 x 400 x 225 |
| MRP (₹) | | 44,015 | |

| OPTIONAL ACCESSORIES | |
|----------------------|-----------------------|
| Wire Grid | Colander |
| - | JC 02 / JS 06 / JR 02 |
| WG 01 | |



| DIMENSIONS | | | |
|----------------|----------------------------------|---------------------|---------------------------------|
| CAT. MODEL | Overall Size (inch/mm) | Bowl Size (inch/mm) | Cabinet Size |
| JS 4520 R | 45 x 20 x 09 1160 x 510 x 225 | 1st Bowl | 16 x 16 x 09 400 x 400 x 225 |
| | | 2nd Bowl | 13 x 16 x 09 340 x 400 x 225 |
| MRP (₹) | | 49,255 | |

| OPTIONAL ACCESSORIES | |
|----------------------|-----------------------|
| Wire Grid | Colander |
| WG 01 | JC 02 / JS 06 / JR 02 |
| WG 04 | |



| DIMENSIONS | | | |
|----------------|----------------------------------|---------------------|---------------------------------|
| CAT. MODEL | Overall Size (inch/mm) | Bowl Size (inch/mm) | Cabinet Size |
| JS 4520 L | 45 x 20 x 09 1160 x 510 x 225 | 1st Bowl | 13 x 16 x 09 340 x 400 x 225 |
| | | 2nd Bowl | 16 x 16 x 09 400 x 400 x 225 |
| MRP (₹) | | 49,255 | |

| OPTIONAL ACCESSORIES | |
|----------------------|-----------------------|
| Wire Grid | Colander |
| WG 04 | JC 02 / JS 06 / JR 02 |
| WG 01 | |



| PRODUCT DESCRIPTION & DIMENSIONS | | |
|----------------------------------|----------------------|---------|
| CAT. MODEL | Features / Size | MRP (₹) |
| JS 1717 WB (With Stand) | 17 x 17 430 x 430 | 30,985 |

*Faucet price not included in M.R.P.
Wash Basin in 3 mm thickness

• Optional customisation of any size possible on request

OPTIONAL ACCESSORIES



Model: JC Series
Colander



Model: JS Series
Colander



Model: JR Series
Colander



Model: DC 01
Drainer Cap



Model: RMR 02
Roll Matt

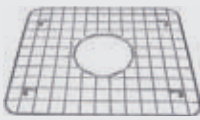

Model: WG Series
Wire Grid



Model: SDR 01
Soap Dispenser

Reference page no 56 & 57



A D V A N T A G E
INGRAINED

Square R-10 Series

JAYNA- SQUARE R-10 SERIES Crafted from High Grade AISI-304 (18/8) - 18% Chrome, 8% Nickel in 1.2 (mm) thickness. Smart Feature, excellent luster, maximum durability and strength. 10 mm radius corners for easier cleaning. 100% Hygienic.

Features —

- 1.2 mm** thickness gives durability and longevity
- Unique brushed
- Modern functional design
- International styling
- Advanced sound deadening technology
- Insect proof concentric coupling

AISI 304 | RUST | LIFETIME | 100% | 145x215
18/8 STEEL | PROOF | WARRANTY | Non-Magnetic | Models Sizes



| DIMENSIONS | | | |
|--------------|---------------------------------|---------------------------------|--------------|
| CAT. MODEL | Overall Size (inch/mm) | Bowl Size (inch/mm) | Cabinet Size |
| JS RC - 2418 | 24 x 18 x 09 610 x 460 x 225 | 22 x 16 x 09 560 x 400 x 225 | 60 cm |
| MRP (₹) | 24,295 | | |

| OPTIONAL ACCESSORIES | |
|----------------------|-----------------------|
| Wire Grid | Colander |
| WGN 03 | JC 02 / JS 06 / JR 02 |



| DIMENSIONS | | | |
|--------------|---|---------------------------------|--------------|
| CAT. MODEL | Overall Size (inch/mm) | Bowl Size (inch/mm) | Cabinet Size |
| JS RC - 2420 | 24 x 20 x 09 610 x 510 x 225 | 22 x 16 x 09 550 x 400 x 225 | 60 cm |
| MRP (₹) | 26,970 Accessories Included: Soap Dispenser | | |

| OPTIONAL ACCESSORIES | |
|----------------------|-----------------------|
| Wire Grid | Colander |
| WGN 03 | JC 02 / JS 06 / JR 02 |



| DIMENSIONS | | | | |
|---------------|---------------------------------|---------------------|---------------------------------|--------------|
| CAT. MODEL | Overall Size (inch/mm) | Bowl Size (inch/mm) | | Cabinet Size |
| JS RC - 3418D | 34 x 18 x 09 860 x 460 x 225 | 1st Bowl | 14 x 16 x 09 380 x 400 x 225 | 90 cm |
| | | 2nd Bowl | 16 x 16 x 09 400 x 400 x 225 | |
| MRP (₹) | 36,995 | | | |

| OPTIONAL ACCESSORIES | |
|----------------------|-----------------------|
| Wire Grid | Colander |
| WGN 05 | JC 02 / JS 06 / JR 02 |



| DIMENSIONS | | | | |
|---------------|---|---------------------|---------------------------------|--------------|
| CAT. MODEL | Overall Size (inch/mm) | Bowl Size (inch/mm) | | Cabinet Size |
| JS RC - 4520D | 45 x 20 x 09 1145 x 510 x 225 | 1st Bowl | 21 x 16 x 09 530 x 400 x 225 | 120 cm |
| | | 2nd Bowl | 21 x 16 x 09 530 x 400 x 225 | |
| MRP (₹) | 50,370 Accessories Included: Soap Dispenser | | | |

| OPTIONAL ACCESSORIES | |
|----------------------|-----------------------|
| Wire Grid | Colander |
| WGN 09 | JC 02 / JS 06 / JR 02 |

OPTIONAL ACCESSORIES



Model: JC Series Colander



Model: JS Series Colander



Model: JR Series Colander



Model: DC 01 Drainer Cap



Model: RMR 02 Roll Matt

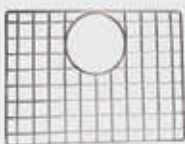

Model: WGN Series Wire Grid



Model: WGN Series Wire Grid

Reference page no 56 & 57



AISI 304 | RUST PROOF | LIFETIME WARRANTY | 100% Non-Magnetic | 14.5x21.5 Models Sizes

Featuring Sink (top):
Designo Series
JD 4620 L (1160 x 500 x 215 mm)

Designo Series

In today's hectic world, people yearn more and more for tranquility and simplicity. Jayna focuses on the basics: the enjoyment of your time in kitchen. There are no distractions. Behold a collection that will never go out of fashion. Surrender to obsession unlimited...

Features —

- 1.0 mm** thickness gives durability and longevity
- Satin finish
- Modern functional design
- International styling
- Advanced sound deadening technology
- Insect proof concentric coupling



| DIMENSIONS | | | |
|------------|---------------------------------|--------------------------------------|--------------|
| CAT. MODEL | Overall Size (inch/mm) | Bowl Size (inch/mm) | Cabinet Size |
| JD 2720 | 27 x 19 x 08 680 x 490 x 210 | 24 x 15 x 08 620 x 375 x 210 | 80 cm |
| MRP (₹) | 24,430 | Accessories Included: Soap Dispenser | |

| OPTIONAL ACCESSORIES | |
|----------------------|----------|
| Wire Grid | Colander |
| - | - |



| DIMENSIONS | | | |
|-----------------------|----------------------------------|--|--------------|
| CAT. MODEL | Overall Size (inch/mm) | Bowl Size (inch/mm) | Cabinet Size |
| JD 3420 R (With Hole) | 34 x 20 x 8.5 860 x 500 x 215 | 18 x 16 x 8.5 450 x 400 x 215 | 80 cm |
| MRP (₹) | 24,720 | Accessories Included: Soap Dispenser With Mixer Hole | |

| OPTIONAL ACCESSORIES | |
|----------------------|-----------------------|
| Wire Grid | Colander |
| WG 06 | JC 02 / JS 06 / JR 02 |



| DIMENSIONS | | | |
|-----------------------|----------------------------------|--|--------------|
| CAT. MODEL | Overall Size (inch/mm) | Bowl Size (inch/mm) | Cabinet Size |
| JD 3420 L (With Hole) | 34 x 20 x 8.5 860 x 500 x 215 | 18 x 16 x 8.5 450 x 400 x 215 | 80 cm |
| MRP (₹) | 24,720 | Accessories Included: Soap Dispenser With Mixer Hole | |

| OPTIONAL ACCESSORIES | |
|----------------------|-----------------------|
| Wire Grid | Colander |
| WG 06 | JC 02 / JS 06 / JR 02 |



| DIMENSIONS | | | |
|------------|-----------------------------------|--|--------------|
| CAT. MODEL | Overall Size (inch/mm) | Bowl Size (inch/mm) | Cabinet Size |
| JD 4020 MR | 40 x 20 x 8.5 1000 x 500 x 215 | 1st Bowl: 14 x 16 x 8.5 350 x 400 x 215 2nd Bowl: 07 x 12 x 5.5 180 x 300 x 135 | 60 cm |
| MRP (₹) | 29,245 | Accessories Included: Soap Dispenser | |

| OPTIONAL ACCESSORIES | |
|----------------------|-----------------------|
| Wire Grid | Colander |
| WG 04 | JC 02 / JS 06 / JR 02 |



| DIMENSIONS | | | |
|------------|-----------------------------------|--|--------------|
| CAT. MODEL | Overall Size (inch/mm) | Bowl Size (inch/mm) | Cabinet Size |
| JD 4020 ML | 40 x 20 x 8.5 1000 x 500 x 215 | 1st Bowl: 07 x 12 x 5.5 180 x 300 x 135 2nd Bowl: 14 x 16 x 8.5 350 x 400 x 215 | 60 cm |
| MRP (₹) | 29,245 | Accessories Included: Soap Dispenser | |

| OPTIONAL ACCESSORIES | |
|----------------------|-----------------------|
| Wire Grid | Colander |
| WG 04 | JC 02 / JS 06 / JR 02 |



| DIMENSIONS | | | |
|------------|-----------------------------------|--|--------------|
| CAT. MODEL | Overall Size (inch/mm) | Bowl Size (inch/mm) | Cabinet Size |
| JD 4620 L | 46 x 20 x 8.5 1160 x 500 x 215 | 1st Bowl: 16 x 14 x 8.5 400 x 350 x 215 2nd Bowl: 14 x 16 x 8.5 350 x 400 x 215 | 80 cm |
| MRP (₹) | 35,030 | Accessories Included: Soap Dispenser | |

| OPTIONAL ACCESSORIES | |
|----------------------|-----------------------|
| Wire Grid | Colander |
| WG 04 | JC 02 / JS 06 / JR 02 |



| DIMENSIONS | | | |
|----------------|----------------------------------|---------------------|--------------|
| CAT. MODEL | Overall Size (inch/mm) | Bowl Size (inch/mm) | Cabinet Size |
| JI 4420 D | 44 x 20 x 08 1130 x 520 x 205 | Ø 17 Ø 425 | 100 cm |
| MRP (₹) | 24,585 | | |

Faucet shown is not part of sink



| DIMENSIONS | | | | |
|----------------|-----------------------------------|----------|---------------------------------|--------------|
| CAT. MODEL | Overall Size (inch/mm) | | Bowl Size (inch/mm) | Cabinet Size |
| JI 3919 | 38.5 x 19 x 08 980 x 480 x 210 | 1st Bowl | 10 x 13 x 08 260 x 340 x 210 | 80 cm |
| | | 2nd Bowl | 15 x 13 x 08 380 x 330 x 210 | |
| MRP (₹) | 23,085 | | | |



| DIMENSIONS | | | | |
|----------------|------------------------------------|----------|---------------------------------|--------------|
| CAT. MODEL | Overall Size (inch/mm) | | Bowl Size (inch/mm) | Cabinet Size |
| JI 4520 R | 45.5 x 20 x 08 1160 x 510 x 225 | 1st Bowl | 14 x 16 x 08 347 x 405 x 210 | 80 cm |
| | | 2nd Bowl | 13 x 14 x 08 330 x 352 x 210 | |
| MRP (₹) | 26,220 | | | |



| DIMENSIONS | | | | |
|----------------|------------------------------------|----------|---------------------------------|--------------|
| CAT. MODEL | Overall Size (inch/mm) | | Bowl Size (inch/mm) | Cabinet Size |
| JI 4520 L | 45.5 x 20 x 08 1160 x 510 x 225 | 1st Bowl | 13 x 14 x 08 330 x 352 x 210 | 80 cm |
| | | 2nd Bowl | 14 x 16 x 08 347 x 405 x 210 | |
| MRP (₹) | 26,220 | | | |



| DIMENSIONS | | | |
|----------------|---------------------------------|-----------------------------------|--------------|
| CAT. MODEL | Overall Size (inch/mm) | Bowl Size (inch/mm) | Cabinet Size |
| AU 3420 | 34 x 20 x 09 850 x 510 x 220 | 17.5 x 17 x 09 445 x 425 x 220 | 80 cm |
| MRP (₹) | 24,000 | | |



| DIMENSIONS | | | |
|----------------|------------------------------------|--|--------------|
| CAT. MODEL | Overall Size (inch/mm) | Bowl Size (inch/mm) | Cabinet Size |
| AU 4520 | 45.5 x 20 x 08 1160 x 500 x 205 | 1st Bowl: 13 x 16 x 08 340 x 400 x 205 2nd Bowl: 13 x 16 x 08 340 x 400 x 205 | 80 cm |
| MRP (₹) | 28,480 | | |



| DIMENSIONS | | | |
|----------------|------------------------------------|--|--------------|
| CAT. MODEL | Overall Size (inch/mm) | Bowl Size (inch/mm) | Cabinet Size |
| AU 4620 | 45.5 x 20 x 08 1160 x 500 x 205 | 1st Bowl: 11 x 17 x 08 285 x 435 x 205 2nd Bowl: 16.5 x 17 x 08 425 x 435 x 205 | 80 cm |
| MRP (₹) | 28,480 | | |

OPTIONAL ACCESSORIES



Model: JC Series
Colander



Model: JS Series
Colander



Model: DC 01
Drainer Cap



Model: RMR 02
Roll Matt



Stainless Steel
Crockery Basket

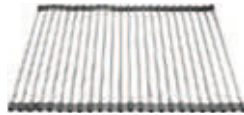

| Roll Matt: Square | | |
|-------------------|--------------|---------|
| CAT. MODEL | Size (mm) | MRP (₹) |
| RMS 01 | 440 x 440 mm | 4,455 |

| Roll Matt: Round | | |
|------------------|--------------|---------|
| CAT. MODEL | Size (mm) | MRP (₹) |
| RMR 02 | 440 x 440 mm | 3,825 |

| Stainless Steel Drainer Cap | | |
|-----------------------------|-----------|---------|
| CAT. MODEL | Size (mm) | MRP (₹) |
| DC 01 | Ø 114 | 855 |



COLANDER (2''): Used for washing cutlery or cleaning food items.

| CAT. MODEL | DIMENSIONS | | MRP (₹) |
|------------|------------------------|----------------------|---------|
| | Overall Size (inch/mm) | Inner Size (inch/mm) | |
| JC 01 | 325 x 475 x 50 | 285 x 435 x 50 | 4,660 |
| JC 02 | 325 x 420 x 50 | 285 x 380 x 50 | 4,410 |
| JC 04 | 325 x 370 x 50 | 285 x 330 x 50 | 4,035 |



COLANDER (5''): Used for washing cutlery or cleaning food items.

| CAT. MODEL | DIMENSIONS | | MRP (₹) |
|------------|------------------------|----------------------|---------|
| | Overall Size (inch/mm) | Inner Size (inch/mm) | |
| JS 05 | 220 x 475 x 125 | 180 x 435 x 125 | 5,150 |
| JS 06 | 220 x 420 x 125 | 180 x 380 x 125 | 4,785 |
| JS 07A | 220 x 370 x 125 | 180 x 330 x 125 | 4,345 |



COLANDER (2''): Used for washing cutlery or cleaning food items.

| CAT. MODEL | DIMENSIONS | | MRP (₹) |
|------------|------------------------|----------------------|---------|
| | Overall Size (inch/mm) | Inner Size (inch/mm) | |
| JR 01 | 250 x 390 x 75 | 250 x 310 x 75 | 4,345 |
| JR 02 | 250 x 440 x 75 | 250 x 360 x 75 | 4,785 |
| JR 03 | 250 x 490 x 75 | 250 x 410 x 75 | 5,280 |



Stainless Steel Tray: A low depth tray which look like a Drain Board & works like colander for the sink area used for washing or other items.

| CAT. MODEL | DIMENSIONS | MRP (₹) |
|------------|----------------|---------|
| | Size (mm) | Glossy |
| SST 01 | 380 x 460 x 30 | 8,545 |
| SST 02 | 380 x 510 x 30 | 10,030 |

SST 01 & SST 02 are 30 mm deep trays which are most appropriate when placed with the single or double bowl sink to create a deeper and more convenient drainboard.

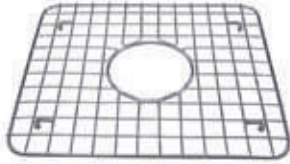

WIRE GRID WITH CENTER POSITION DRAINER

| DIMENSIONS | | MRP (₹) |
|------------|-----------|---------|
| CAT. MODEL | Size (mm) | |
| WG 01 | 390 X 390 | 2,235 |
| WG 02 | 540 X 390 | 3,105 |
| WG 02A | 520 X 390 | 3,105 |
| WG 04 | 330 x 390 | 2,235 |
| WG 05 | 370 x 320 | 2,235 |
| WG 06 | 440 x 390 | 2,730 |
| WG 07 | 520 x 440 | 3,725 |



SOAP DISPENSER

| Suitable for | | MRP (₹) |
|--------------|---------------|---------|
| CAT. MODEL | Designo Sinks | |
| SDR 01 | | 2,190 |

SOAP DISPENSER ROUND

For a convenient access to the soap for washing hands or utensils to maintain a hygienic work environment.

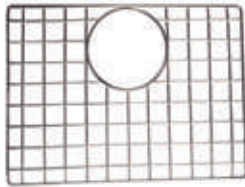

WIRE GRID WITH REAR POSITION DRAINER

| DIMENSIONS | | MRP (₹) |
|------------|-----------|---------|
| CAT. MODEL | Size (mm) | |
| WGN 01 | 390 X 340 | 2,235 |
| WGN 02 | 470 X 390 | 3,105 |
| WGN 03 | 540 X 390 | 3,105 |

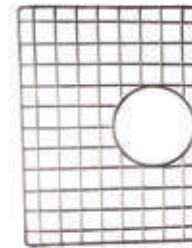

WIRE GRID WITH REAR POSITION DRAINER

| DIMENSIONS | | MRP (₹) |
|------------|-----------|---------|
| CAT. MODEL | Size (mm) | |
| WGN 05 | 390 X 390 | 2,235 |
| WGN 06 | 450 X 390 | 3,105 |
| WGN 08 | 440 X 390 | 3,105 |
| WGN 09 | 517 X 390 | 3,480 |



Glass Rinser

| Finish | | MRP (₹) |
|------------|--------|---------|
| CAT. MODEL | | |
| JGR 01 | Chrome | 5500 |



Wooden Chopping Board

| MRP (₹) | |
|------------|-------|
| CAT. MODEL | |
| WCB 06 | 2,700 |



STAINLESS STEEL DRAINER CAP

| Size (mm) | | MRP (₹) |
|------------|-------|---------|
| CAT. MODEL | | |
| DC 01 | Ø 114 | 855 |



ROLL MATT (Square)

| Size (mm) | | MRP (₹) |
|------------|-----------|---------|
| CAT. MODEL | | |
| RMS 01 | 440 x 440 | 4,455 |



ROLL MATT (Round)

| Size (mm) | | MRP (₹) |
|------------|-----------|---------|
| CAT. MODEL | | |
| RMR 02 | 440 x 440 | 3,825 |

304
stainless steel
faucets _



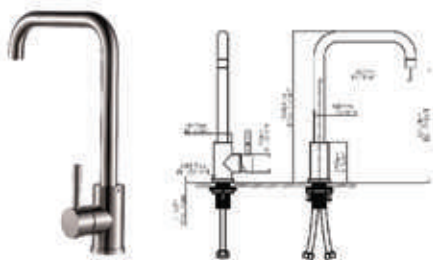

| CAT. MODEL | MRP (₹) |
|------------|---------|
| SF 01A | 9,150 |

Finish : Satin



| CAT. MODEL | MRP (₹) |
|------------|---------|
| SF 02 | 9,705 |

Finish : Satin



| CAT. MODEL | MRP (₹) |
|------------|---------|
| SF 04 | 20,690 |

Finish : Satin



| CAT. MODEL | MRP (₹) |
|------------|---------|
| SF 05 AR | 15,450 |

Finish : Satin

Orientable spout with 2 internal separated pipes. Right handle for standard mixers, left handle for RO/Drinking Water.



| CAT. MODEL | MRP (₹) |
|-----------------|---------|
| SF 09 F (SATIN) | 3,650 |

Filter Faucet For RO/Drinking Water



| CAT. MODEL | MRP (₹) |
|-----------------|---------|
| SF 09 F (BLACK) | 4,750 |

Filter Faucet For RO/Drinking Water



| CAT. MODEL | MRP (₹) |
|----------------|---------|
| SF 09 F (GOLD) | 4,950 |

Filter Faucet For RO/Drinking Water



| CAT. MODEL | MRP (₹) |
|---------------------|---------|
| SF 09 F (ROSE GOLD) | 5,500 |

Filter Faucet For RO/Drinking Water

COLLECTION INTERNATIONAL



KITCHEN FAUCETS

Featuring Tap:
Cat. Model - BF 08 P
Single Lever Kitchen Pullout Mixer



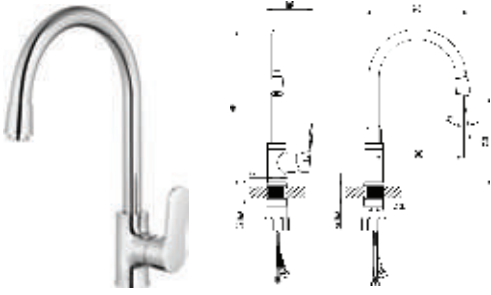

| CAT. MODEL | MRP (₹) |
|------------|---------|
| BF 01 | 8,030 |

Finish: Chrome

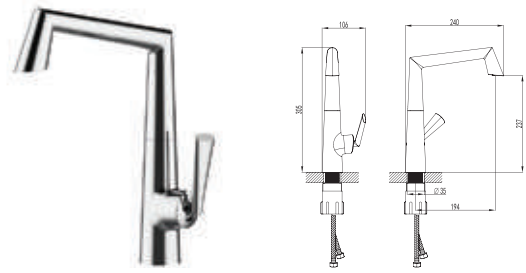

| CAT. MODEL | MRP (₹) |
|------------|---------|
| BF 02 | 13,340 |

Finish: Chrome

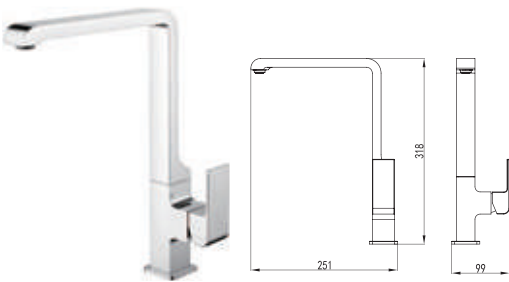

| CAT. MODEL | MRP (₹) |
|------------|---------|
| BF 04 | 17,710 |

Finish: Chrome

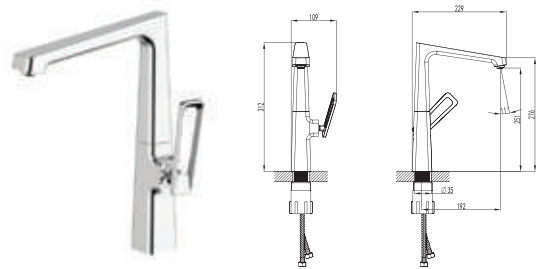

| CAT. MODEL | MRP (₹) |
|------------|---------|
| BF 05 | 16,675 |

Finish: Chrome

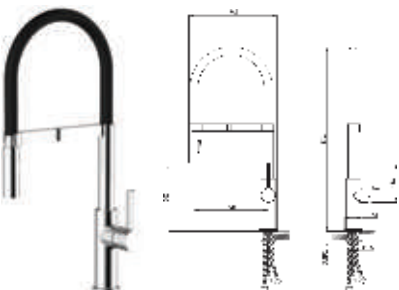

| CAT. MODEL | MRP (₹) |
|------------|---------|
| BF 06R | 20,100 |

Finish: Chrome
With RO Filter Function



| CAT. MODEL | MRP (₹) |
|------------|---------|
| BF 07P | 15,600 |

Finish: Chrome
∴ Pullout Mixer

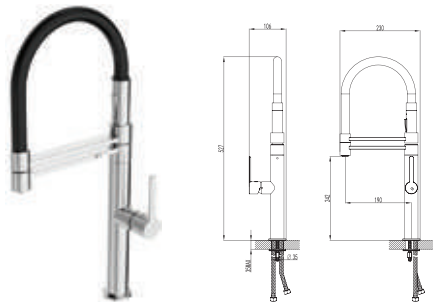

| CAT. MODEL | MRP (₹) |
|------------|---------|
| BF 08P | 21,735 |

Finish: Chrome
∴ Pullout Mixer

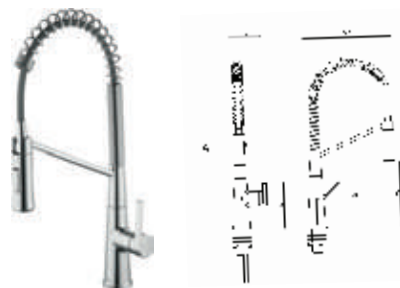

| CAT. MODEL | MRP (₹) |
|------------|---------|
| BF 09P | 21,710 |

Finish: Chrome
∴ Pullout Mixer

COLLECTION INTERNATIONAL



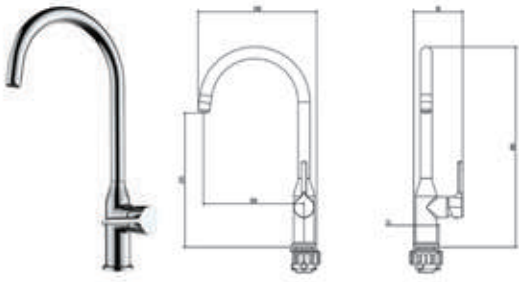

| CAT. MODEL | MRP (₹) |
|------------|---------|
| BF 10R | 9,920 |

Finish: Chrome
With RO Filter Function

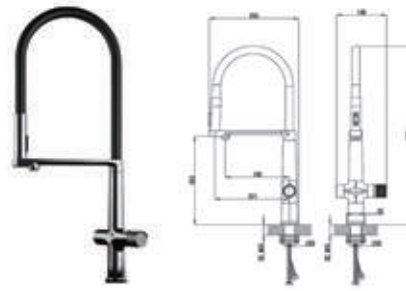

| CAT. MODEL | MRP (₹) |
|------------|---------|
| BF 11C | 27,550 |

Finish: Chrome



| CAT. MODEL | MRP (₹) |
|------------|---------|
| BF 12B | 34,500 |

Finish: Gun Metal

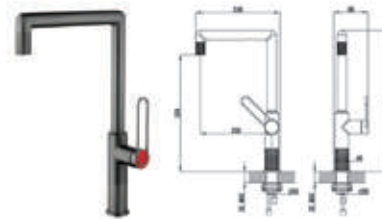

| CAT. MODEL | MRP (₹) |
|------------|---------|
| BF 13GB | 26,550 |

Finish: Gun Metal

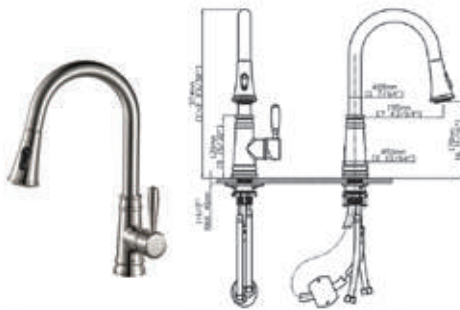

| CAT. MODEL | MRP (₹) |
|------------|---------|
| BF 014 | 20,800 |

Finish: Chrome

•• Pullout Mixer



Black & Gold

| CAT. MODEL | MRP (₹) | | |
|------------|--------------|------------------------|-------------------|
| | Black & Gold | Black & Brushed Nickle | Black & Rose Gold |
| BF 15 | 26,950 | 26,950 | 26,950 |

•• Pullout Mixer



| CAT. MODEL | MRP (₹) |
|------------|---------|
| BF 16 | 45,150 |

Finish: Chrome

•• Pullout Mixer



Black & Gold



Black & Brushed Nickle



Black & Rose Gold

SMART
SERIES



SMART SERIES
LINEAR SHOWER
CHANNEL



Jayna Shower Channel

A Linear Shower channel is a must for absolutely every bathroom. Due to its unique anti-odour design, low installation height, high flow rate and wide assortment of stainless steel grids, it meets requirements of demanding clients - and is an ideal solution for your bathroom.

The bottom part is made from polypropylene, the drain frame and the cover grid are made from stainless steel 304 Grade, allowing for a K3 load (up to 300 kg). The minimum installation height is 65mm, the drain is height-adjustable. To connect to sewage pipes \varnothing 40/50mm. The package includes a self-adhesive waterproofing membrane, adjustable spacers, nylon plugs, a plastic key to remove the stainless steel grid and the assembly instructions.

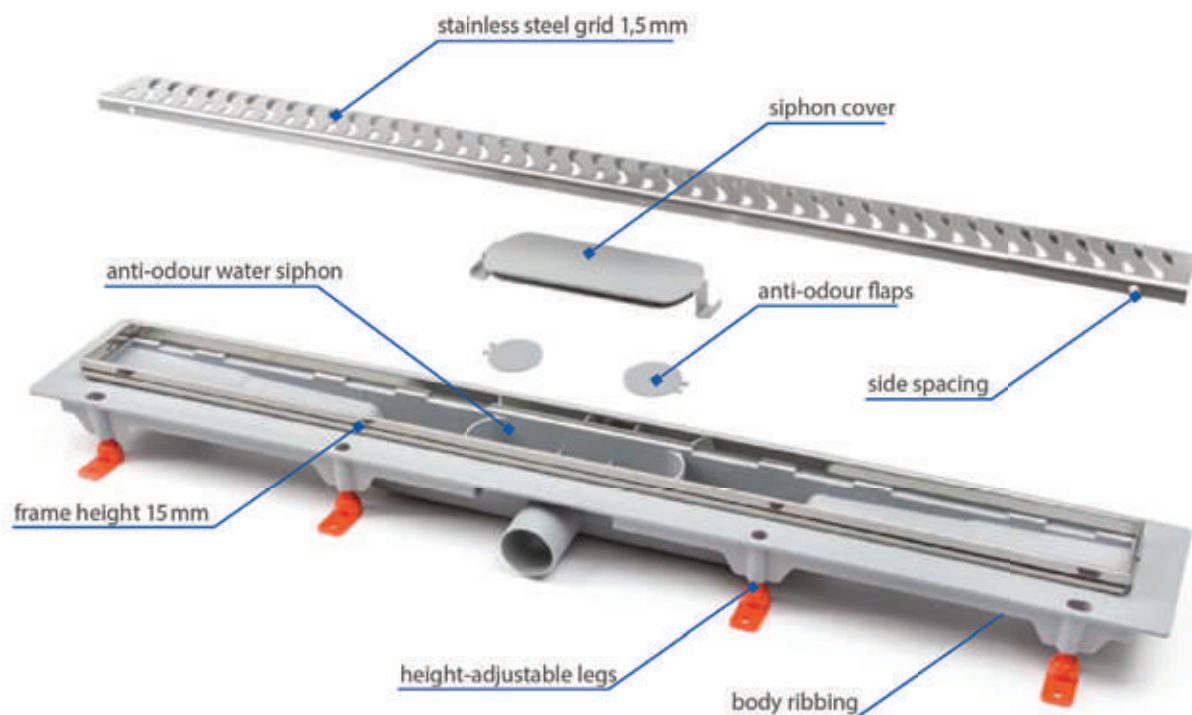

BENEFITS

- Low installation height 65mm
- Drain frame height 15mm
- Drain height adjustment between 65 - 125mm
- Flow rate 30 - 70 L/min
- Combined siphon: water level and a dry flap
- Load capacity k3 (300 kg)
- Stainless steel 304 grid 1.5mm matt
- Dimension range 650, 750, 950 mm
- Installation options: to the open space/to the wall
- Easy dismantling when cleaning
- Option with a stainless steel frame
- Option with a grid for tiles / marble
- Outlet option side
- Self-adhesive waterproofing membrane included

Note: Kindly refer for installation guide to our Youtube channel



Scan the QR to visit our youtube channel for Installation Video

Linear Shower Channel without Stainless Steel Frame, outlet D50

FLOW RATE
46-52
l/min

MIN. HEIGHT
80
mm

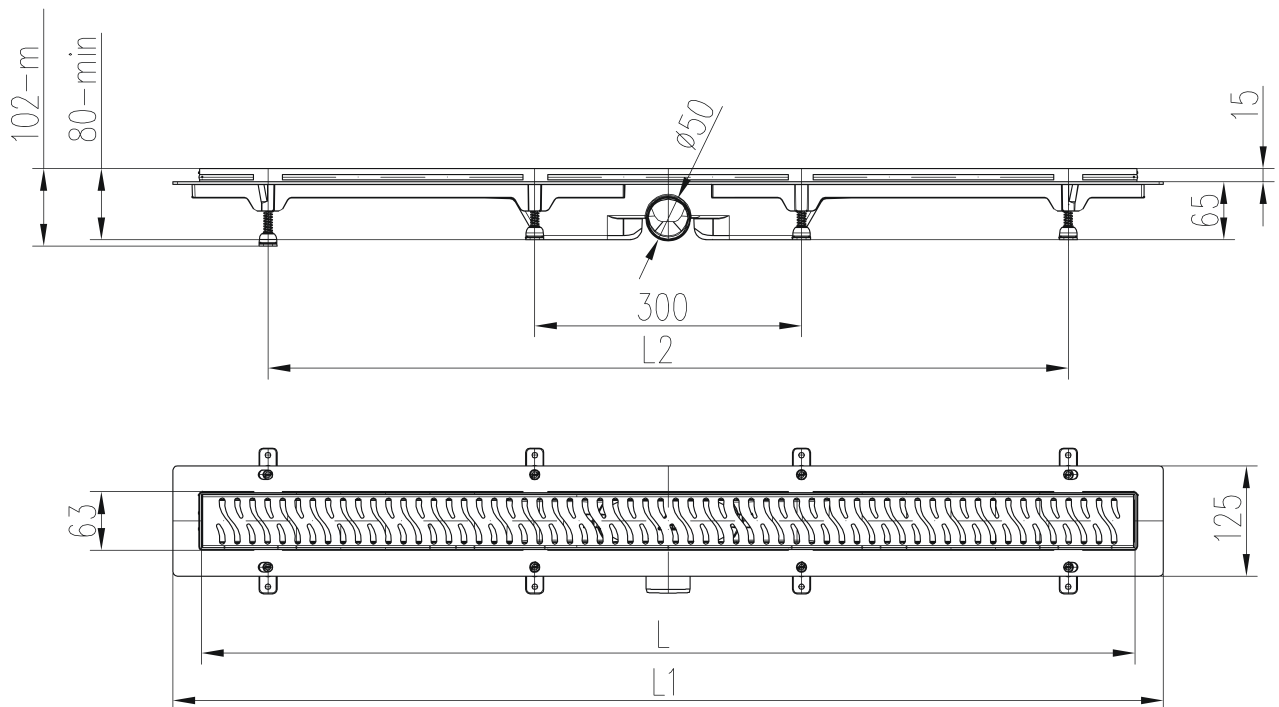
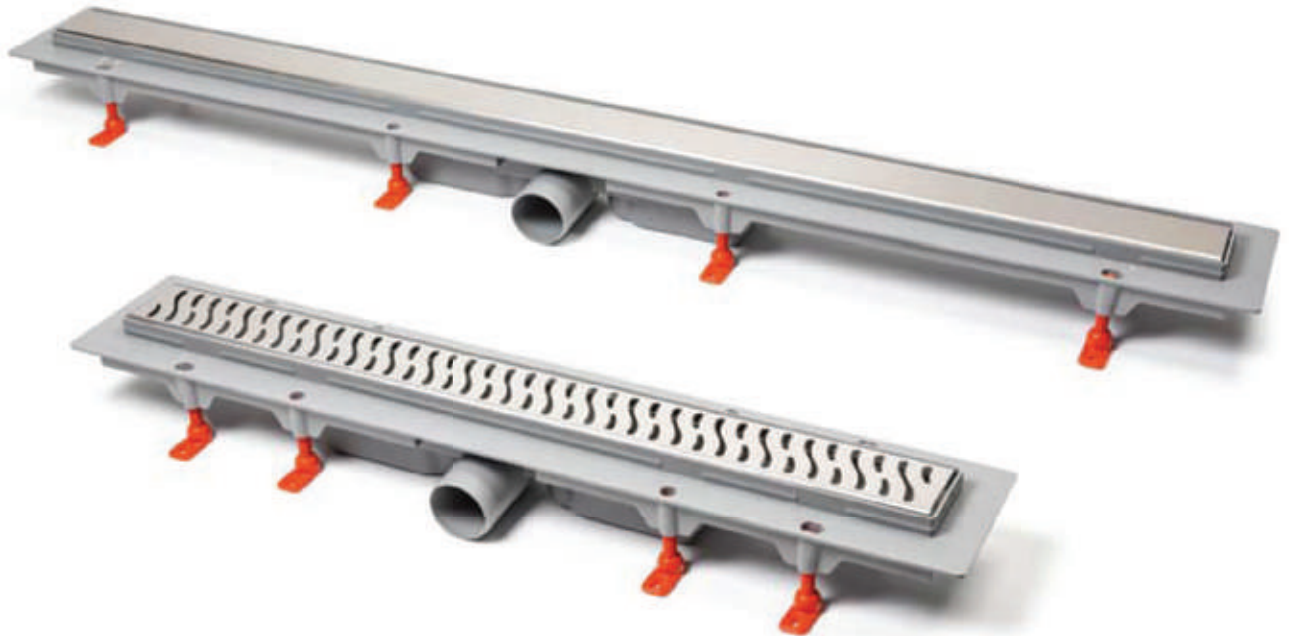



| Model No | W x L (mm) | Height Adjustable (mm) | MRP |
|-------------|------------|------------------------|--------|
| Classic 650 | 63x650 | 80-102 | 11,980 |
| Classic 750 | 63x750 | 80-102 | 12,730 |
| Classic 950 | 63x950 | 80-102 | 14,870 |

Classic Range: RectangularTile / Marble Insert Channel



| Model No | W x L (mm) | Height Adjustable (mm) | MRP |
|-------------|------------|------------------------|--------|
| Harmony 650 | 63x650 | 80-102 | 10,810 |
| Harmony 750 | 63x750 | 80-102 | 11,560 |
| Harmony 950 | 63x950 | 80-102 | 13,590 |



| Model No | W x L (mm) | Height Adjustable (mm) | MRP |
|------------|------------|------------------------|--------|
| Medium 650 | 63x650 | 80-102 | 10,810 |
| Medium 750 | 63x750 | 80-102 | 11,560 |
| Medium 950 | 63x950 | 80-102 | 13,590 |



| Accessory | Outlet | MRP |
|------------|---------------------|-----|
| Reducer 01 | From 50 mm to 40 mm | 480 |

Linear Shower Channel with Stainless Steel Frame, outlet D50

FLOW RATE
46-52
l/min

MIN. HEIGHT
80
mm

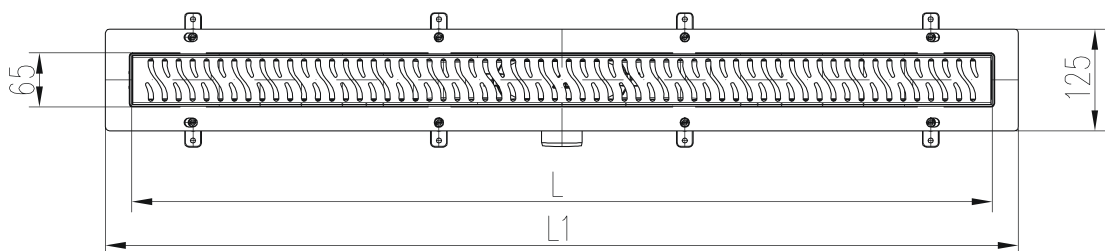
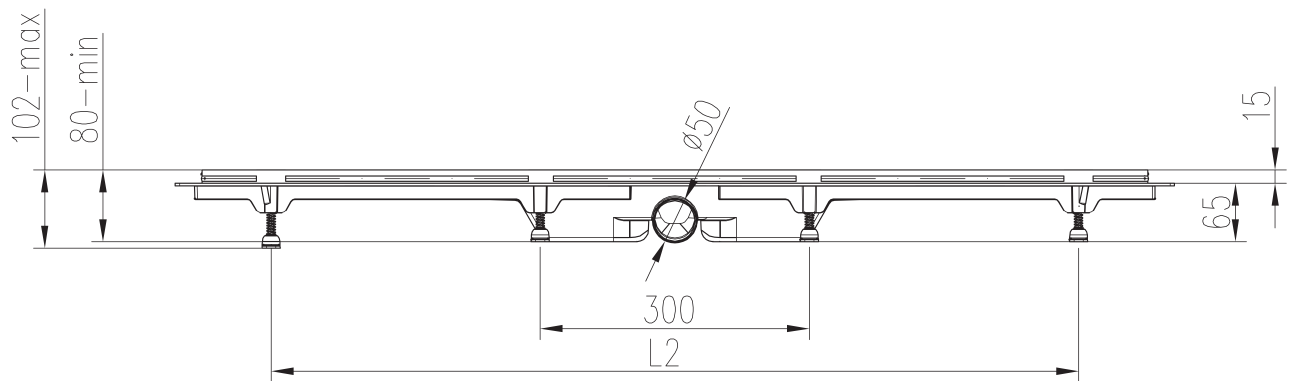



| Model No | W x L (mm) | Height Adjustable (mm) | MRP |
|----------------|------------|------------------------|--------|
| Classic DX 650 | 65x650 | 80-102 | 14,870 |
| Classic DX 750 | 65x750 | 80-102 | 15,940 |
| Classic DX 950 | 65x950 | 80-102 | 18,730 |

Classic Range: RectangularTile / Marble Insert Channel



| Model No | W x L (mm) | Height Adjustable (mm) | MRP |
|----------------|------------|------------------------|--------|
| Harmony DX 650 | 65x650 | 80-102 | 13,700 |
| Harmony DX 750 | 65x750 | 80-102 | 14,450 |
| Harmony DX 950 | 65x950 | 80-102 | 17,010 |



| Model No | W x L (mm) | Height Adjustable (mm) | MRP |
|---------------|------------|------------------------|--------|
| Medium DX 650 | 65x650 | 80-102 | 13,700 |
| Medium DX 750 | 65x750 | 80-102 | 14,450 |
| Medium DX 950 | 65x950 | 80-102 | 17,010 |



| Model No | W x L (mm) | Height Adjustable (mm) | MRP |
|---------------|------------|------------------------|--------|
| Square DX 650 | 65x650 | 80-102 | 13,700 |
| Square DX 750 | 65x750 | 80-102 | 14,450 |
| Square DX 950 | 65x950 | 80-102 | 17,010 |



| Accessory | Outlet | MRP |
|------------|---------------------|-----|
| Reducer 01 | From 50 mm to 40 mm | 480 |

Linear Shower Channel to the wall with stainless steel frame, Outlet D40/D50

FLOW RATE
30-38
l/min

MIN. HEIGHT
65
mm

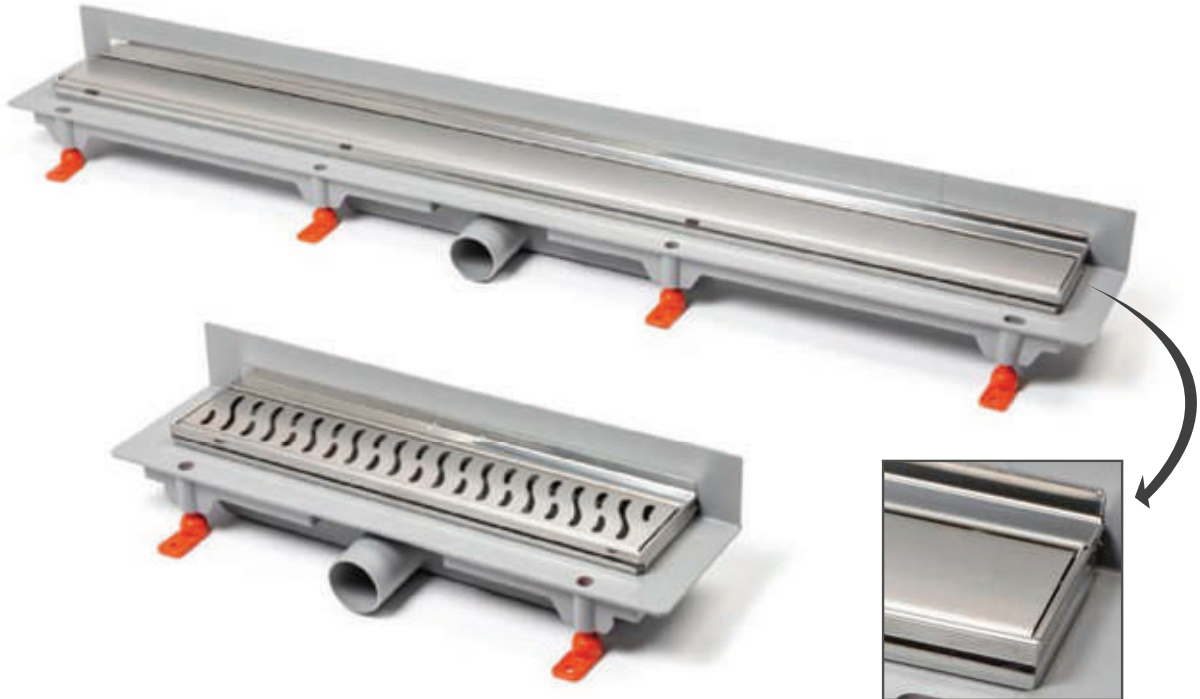

Stainless Steel Frame

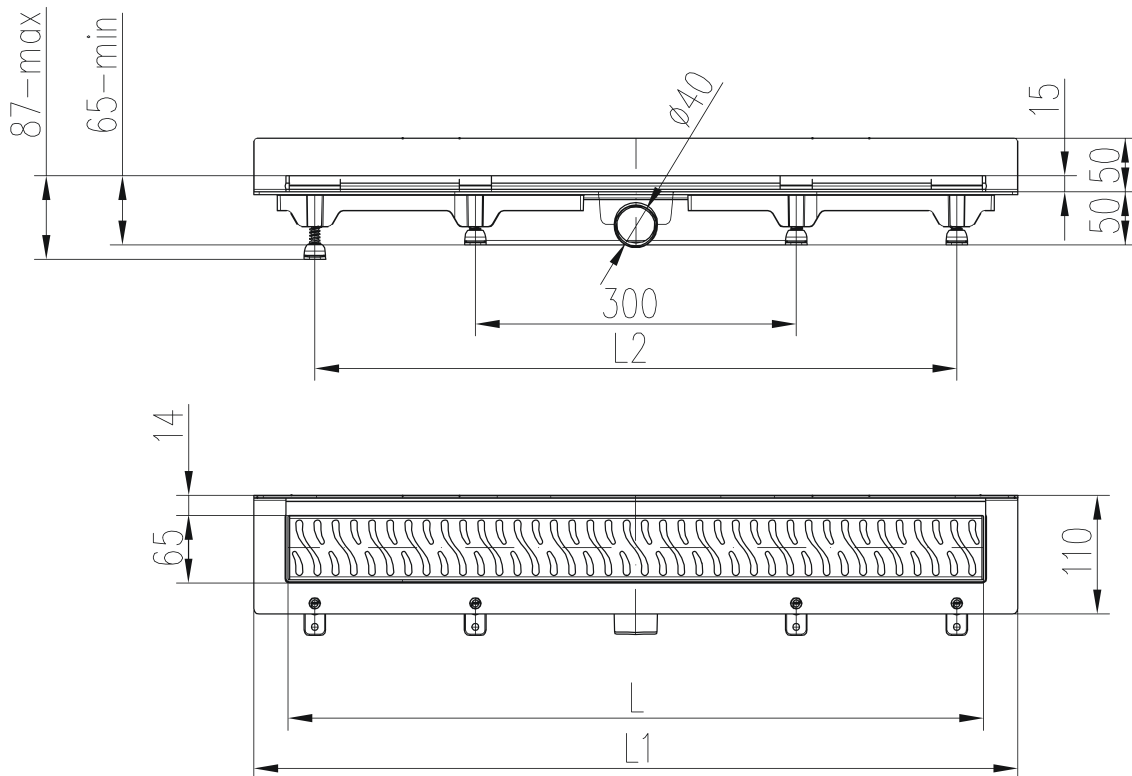



| Model No | W x L (mm) | Height Adjustable (mm) | MRP |
|---------------------|------------|------------------------|--------|
| Classic Wall DX 650 | 65x650 | 65-87 | 19,800 |

Classic Range: RectangularTile / Marble Insert Channel



| Model No | W x L (mm) | Height Adjustable (mm) | MRP |
|---------------------|------------|------------------------|--------|
| Harmony Wall DX 650 | 65x650 | 65-87 | 18,730 |



| Model No | W x L (mm) | Height Adjustable (mm) | MRP |
|--------------------|------------|------------------------|--------|
| Medium Wall DX 650 | 65x650 | 65-87 | 18,730 |

SMART SERIES

Jayna

NEW
SERIES

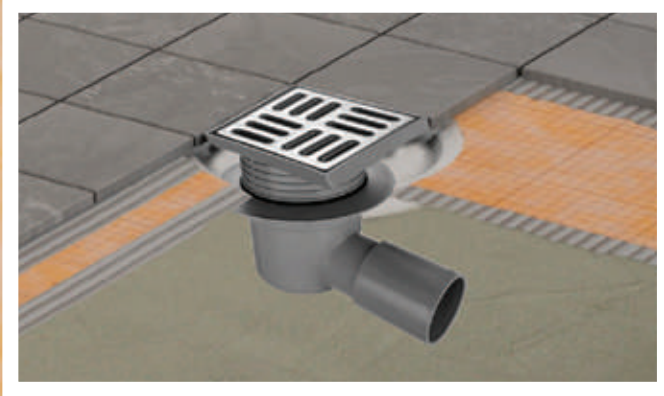



| DIMENSIONS | | MRP (₹) |
|------------|-----------|---------|
| Cat. Model | Size (mm) | Matt |
| SFD 01 | 102 x 102 | 1,150 |
| SFD 02 | 127 x 127 | 1,240 |



| DIMENSIONS | | MRP (₹) |
|------------|-----------|---------|
| Cat. Model | Size (mm) | Matt |
| SFD 01A | 102 x 102 | 1,150 |
| SFD 02A | 127 x 127 | 1,240 |

Description —

- **Drainage Capacity:** 35 - 40 L/Min
- **Inlet Size:** 50 mm
- **Grate Size:** 100 x 100 mm
- **Grate Material:** Stainless Steel 304
- **Odour Trap:** Removable

INSTALLATION INSTRUCTIONS



STEP-4
Put the final grit.

STEP-3
To install the adjustment body after putting water proofing paper & then level it with flooring (Tile or marble). Also cover it with red lid to prevent dust from entering the pipes

STEP-2
To put the overflow & cockroach trap body inside collection tank.

STEP-1
To install the collection tank at the time of leveling of the floor.

PVD SHOWER CHANNELS



PVD Shower Channels

Jayna PVD Shower Channels is designed to meet highest aesthetic demand with its stylish & attractive finishes, the PVD Shower channels perfectly complements all design of wellness bathrooms. It offers option of different colours & sizes to customers to create the bathroom on basis of their taste and preferences.

Features —

- Easy to install & clean
- Aesthetic Look
- Available in different colours & sizes
- Durable & Long servicing product.
- Ideal for bathrooms, homes, hotels etc.
- Drainer is provided along with each shower channel.

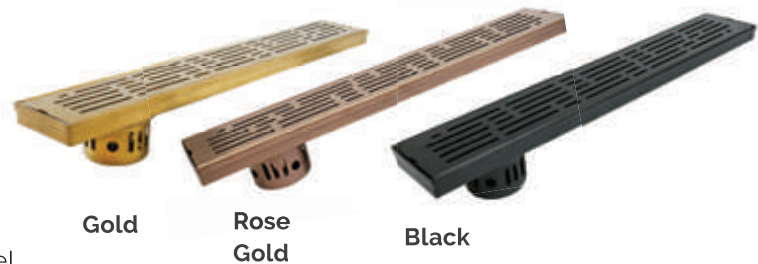

AISI 304 | RUST PROOF | 1/5x215 | PVD



PVD PARKER

| DIMENSIONS | | MRP (₹) | | |
|------------|-------------------|---------|-----------|--------|
| Cat. Model | Overall Size (mm) | Gold | Rose Gold | Black |
| PPSC 450 | 100 x 450 X 25 | 15,530 | 15,530 | 15,530 |
| PPSC 600 | 100 x 600 X 25 | 17,580 | 17,580 | 17,580 |
| PPSC 1000 | 100 x 1000 X 25 | 22,750 | 22,750 | 22,750 |



PVD CARTIER

| DIMENSIONS | | MRP (₹) | | |
|------------|-------------------|---------|-----------|--------|
| Cat. Model | Overall Size (mm) | Gold | Rose Gold | Black |
| PCSC 450 | 100 x 450 X 30 | 12,385 | 12,385 | 12,385 |
| PCSC 600 | 100 x 600 X 30 | 14,015 | 14,015 | 14,015 |
| PCSC 800 | 100 x 800 X 30 | 15,905 | 15,905 | 15,905 |



PVD MAGNUM RECTANGULAR

| DIMENSIONS | | MRP (₹) | | |
|------------|-------------------|---------|-----------|--------|
| Cat. Model | Overall Size (mm) | Gold | Rose Gold | Black |
| PMSC 600 | 100 x 600 x 30 | 21,605 | 21,605 | 21,605 |
| PMSC 750 | 100 x 750 x 30 | 24,265 | 24,265 | 24,265 |



PVD MAGNUM SQUARE

| DIMENSIONS | | MRP (₹) | | |
|------------|-------------------|---------|-----------|-------|
| Cat. Model | Overall Size (mm) | Gold | Rose Gold | Black |
| PMSC 102 | 102 x 102 x 30 | 6,140 | 6,140 | 6,140 |
| PMSC 125 | 125 x 125 x 30 | 6,730 | 6,730 | 6,730 |



PVD NEON FLOOR DRAIN

| DIMENSIONS | | MRP (₹) | | |
|------------|-------------------|---------|-----------|-------|
| Cat. Model | Overall Size (mm) | Gold | Rose Gold | Black |
| PNSF 102 | 102 x 102 | 1,990 | 1,990 | 1,990 |
| PNSF 127 | 127 x 127 | 2,290 | 2,290 | 2,290 |



PVD WONDER FLOOR DRAIN

| DIMENSIONS | | MRP (₹) | | |
|------------|-------------------|---------|-----------|-------|
| Cat. Model | Overall Size (mm) | Gold | Rose Gold | Black |
| PWSF 01 | 127 x 127 | 2,400 | 2,400 | 2,400 |



PVD WONDER FLOOR DRAIN

| DIMENSIONS | | MRP (₹) | | |
|------------|-------------------|---------|-----------|-------|
| Cat. Model | Overall Size (mm) | Gold | Rose Gold | Black |
| PWSF 02 | 127 x 127 | 2,400 | 2,400 | 2,400 |



PVD WONDER FLOOR DRAIN

| DIMENSIONS | | MRP (₹) | | |
|------------|-------------------|---------|-----------|-------|
| Cat. Model | Overall Size (mm) | Gold | Rose Gold | Black |
| PWSF 03 | 127 x 127 | 2,400 | 2,400 | 2,400 |

SHOWER CHANNELS



Shower Channel

Art is the visual expression of design. JAYNA shower channels offer a more artistic solution to shower drainage, taking the design to an even higher form. These high-quality channels meet all the practical, aesthetic and functional demands of today's contemporary showers and wet rooms. The channels meet the relevant sound insulation requirements, providing more peace and quiet in your home.

Jayna shower channels are available in various models. Each model comes in different lengths. These channels are specially designed for your requirements.

Thanks to sophisticated technology and intelligent details, plumbers can easily install these. Discover the exclusive world of JAYNA.

Features

- Easy to install and clean
- No more insect menace
- Prevents choking of drain and bad odour
- Ideal for bathrooms, homes, malls, hotels...
- Sizes available from 300 mm to 1000 mm and above
- Customised sizes also available as per requirement
- Drainer is provided along with each Shower Channel

AISI 304
18/8 STEEL

RUST
PROOF

LIFETIME
WARRANTY

100%
Non-Magnetic



PARKER
SHOWER CHANNEL

| DIMENSIONS | | MRP (₹) |
|------------|-------------------|---------|
| Cat. Model | Overall Size (mm) | Matt |
| PSC 06 | 82 x 300 x 25 | 5,860 |
| PSC 07 | 82 x 450 x 25 | 6,740 |
| PSC 08 | 82 x 600 x 25 | 7,630 |
| PSC 09 | 82 x 750 x 25 | 8,640 |
| PSC 10 | 82 x 1000 x 25 | 9,930 |
| PSC 11 | 100 x 300 x 25 | 6,740 |
| PSC 12 | 100 x 450 x 25 | 7,770 |
| PSC 13 | 100 x 600 x 25 | 8,790 |
| PSC 14 | 100 x 750 x 25 | 9,970 |
| PSC 15 | 100 x 1000 x 25 | 11,370 |

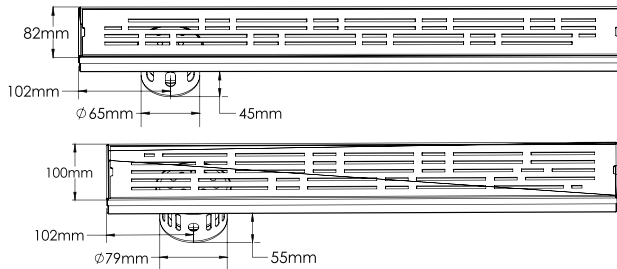

JADORE
SHOWER CHANNEL

| DIMENSIONS | | MRP (₹) |
|------------|-------------------|---------|
| Cat. Model | Overall Size (mm) | Matt |
| JSC 01 | 100 x 300 x 30 | 5,360 |
| JSC 02 | 100 x 450 x 30 | 6,190 |
| JSC 03 | 100 x 600 x 30 | 7,010 |
| JSC 04 | 100 x 800 x 30 | 7,950 |
| JSC 05 | 100 x 1000 x 30 | 9,140 |

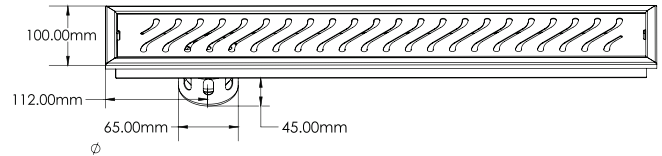

CARTIER
SHOWER CHANNEL

| DIMENSIONS | | MRP (₹) |
|------------|-------------------|---------|
| Cat. Model | Overall Size (mm) | Matt |
| CSC 06 | 100 x 300 x 30 | 5,360 |
| CSC 07 | 100 x 450 x 30 | 6,190 |
| CSC 08 | 100 x 600 x 30 | 7,010 |
| CSC 09 | 100 x 800 x 30 | 7,950 |
| CSC 10 | 100 x 1000 x 30 | 9,140 |
| CSC 11 | 125 x 300 x 30 | 5,780 |
| CSC 12 | 125 x 450 x 30 | 6,710 |
| CSC 13 | 125 x 600 x 30 | 7,550 |
| CSC 14 | 125 x 800 x 30 | 8,480 |
| CSC 15 | 125 x 1000 x 30 | 9,660 |
| CSC 16 | 150 x 600 x 30 | 9,060 |
| CSC 17 | 150 x 1000 x 30 | 11,640 |
| CSC 21 | 125 x 1200 x 30 | 12,760 |
| CSC 22 | 125 x 1500 x 30 | 15,910 |
| CSC 23 | 125 x 2000 x 30 | 21,250 |
| CSC 24 | 150 x 1500 x 30 | 19,060 |

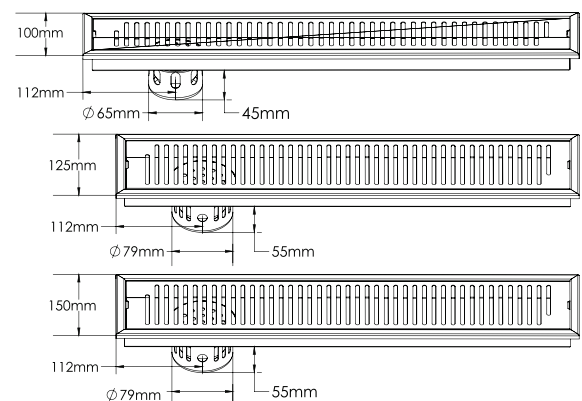

WATER DRAINER

Each shower channel is fitted with AISI-304 (18/8) grade stainless steel Water Drainer. It gives freedom from insects, cockroaches and bad odour.

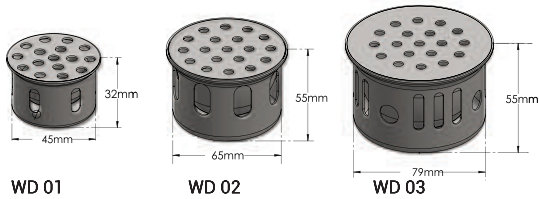

***Shower Channel Customisation possible of any size on request up to 2200 mm single piece.**



Shower Channels

Jayna Shower Channels are available in various models Each model comes in different length. These channels are specially designed lengths. These channels are specially designed for your requirements.

Thanks to sophisticated technology and intelligent details, plumbers can easily install. Discover the exclusive world of JAYNA

Features —

- Easy to install & clean
- No more insect menace
- Prevents choking of drain and bad odour
- Ideal for bathrooms, homes, malls, hotels...
- Sizes available from 300mm to 1000mm and above
- Customised sizes also available as per requirement
- Drainer is provided along with each Shower Channel

AISI 304
18/8 STEEL | RUST
PROOF | L I F E T I M E
WARRANTY | 100%
Non-Magnetic



ULTRA
SHOWER CHANNEL

| DIMENSIONS | | MRP (₹) |
|------------|-------------------|---------|
| Cat. Model | Overall Size (mm) | Matt |
| USC 01 | 125 x 300 x 30 | 5,780 |
| USC 02 | 125 x 450 x 30 | 6,710 |
| USC 03 | 125 x 600 x 30 | 7,550 |
| USC 04 | 125 x 800 x 30 | 8,480 |
| USC 05 | 125 x 1000 x 30 | 9,660 |

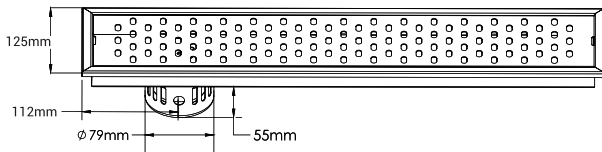

QUADRO
SHOWER CHANNEL

| DIMENSIONS | | MRP (₹) |
|------------|-------------------|---------|
| Cat. Model | Overall Size (mm) | Matt |
| QSC 02 | 82 x 450 x 25 | 7,750 |
| QSC 03 | 82 x 600 x 25 | 9,520 |

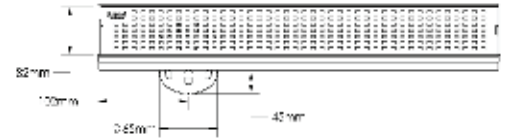

CCSC
CARTIER CORNER SHOWER CHANNEL

| DIMENSIONS | | MRP (₹) |
|------------|-------------------|---------|
| Cat. Model | Overall Size (mm) | Matt |
| CCSC 02 | 127 x 450 x 450 | 10,500 |
| CCSC 03 | 127 x 600 x 600 | 11,600 |

Depth 30mm

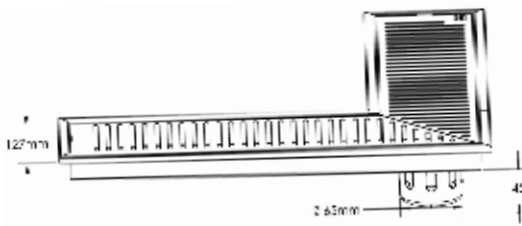

WATER DRAINER

Each shower channel is fitted with AISI-304 (18/8) grade stainless steel Water Drainer. It gives freedom from insects, cockroaches and bad odour.

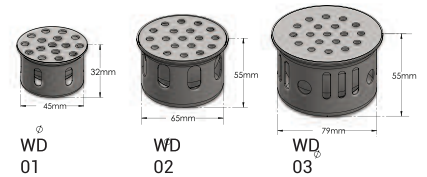



Magnum

Marble / Tile Insert Channel

Marble/Tile Insert channels are not only aesthetically appealing but are also easy to use & clean. Unlike many other conventional Marble/Tile Insert channels, the open outlet surface ensures that neither dirt nor bacteria is able to accumulate. Available in both square point drain and linear styles, they can be used for new builds, bathroom renovations, as well as drain replacements.

Features

- Open outlet surface: no hidden deposits
- Handy cover: easy and convenient to open
- Prevents choking of drain and bad odour
- Available in Rectangular and Square sizes
- Easy installation: complete installation kit for effortless installation and cleaning
- Customized sizes also available as per requirement
- Drainer is provided along with each Shower Channel

WATER DRAINER

Each shower channel is fitted with AISI-304 (18/8) grade stainless steel Water Drainer. It gives freedom from insects, cockroaches and bad odour.

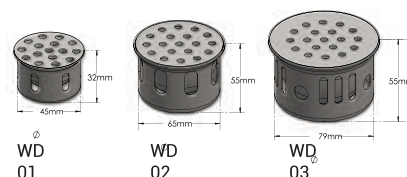

***Shower Channel Customisation possible of any size on request up to 2200 mm single piece.**



ARDEN RECTANGULAR TILE INSERT CHANNEL

Thickness 2.5 mm

| DIMENSIONS | | MRP (₹) |
|------------|-------------------|---------|
| Cat. Model | Overall Size (mm) | Matt |
| ASC 01 | 100 x 200 x 22 | 5,300 |
| ASC 02 | 100 x 300 x 22 | 7,300 |
| ASC 03 | 100 x 450 x 22 | 8,830 |
| ASC 04 | 100 x 600 x 22 | 10,010 |
| ASC 05 | 100 x 800 x 22 | 11,190 |
| ASC 05A | 100 x 1000 x 22 | 12,730 |

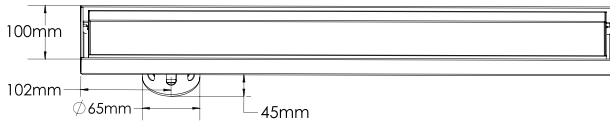

ARDEN SQUARE TILE INSERT CHANNEL

Thickness 2.5 mm

| DIMENSIONS | | MRP (₹) |
|------------|-------------------|---------|
| Cat. Model | Overall Size (mm) | Matt |
| ASC 06 | 102 x 102 x 20 | 2,410 |
| ASC 07 | 125 x 125 x 20 | 2,660 |
| ASC 08 | 150 x 150 x 20 | 3,370 |
| ASC 09 | 200 x 200 x 20 | 6,190 |

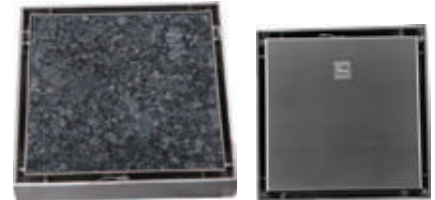
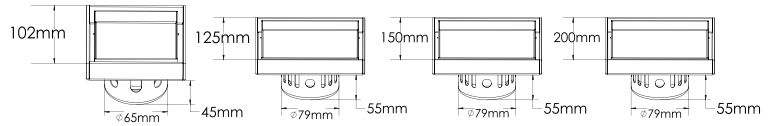

MAGNUM RECTANGULAR MARBLE INSERT CHANNEL

Thickness 2.5 mm

| DIMENSIONS | | MRP (₹) |
|------------|-------------------|---------|
| Cat. Model | Overall Size (mm) | Matt |
| MSC 01 | 100 x 600 x 30 | 10,800 |
| MSC 02 | 100 x 750 x 30 | 12,130 |
| MSC 03 | 100 x 1000 x 30 | 14,440 |

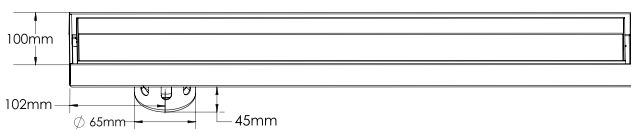

MARBLE/TILE INSERT

CORNER SHOWER CHANNEL Thickness 2.5mm

| DIMENSIONS | | MRP (₹) |
|------------|-------------------|---------|
| Cat. Model | Overall Size (mm) | Matt |
| CMSC 02 | 100 x 450 x 450 | 12,700 |
| CMSC 03 | 100 x 600 x 600 | 15,200 |

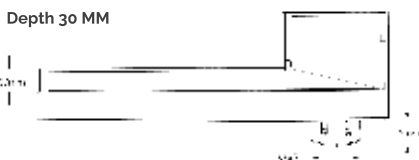

MAGNUM SQUARE MARBLE INSERT CHANNEL

Thickness 2.5 mm

| DIMENSIONS | | MRP (₹) |
|------------|-------------------|---------|
| Cat. Model | Overall Size (mm) | Matt |
| MSC 06 | 102 x 102 x 30 | 2,730 |
| MSC 07 | 125 x 125 x 30 | 2,990 |
| MSC 08 | 150 x 150 x 30 | 3,630 |

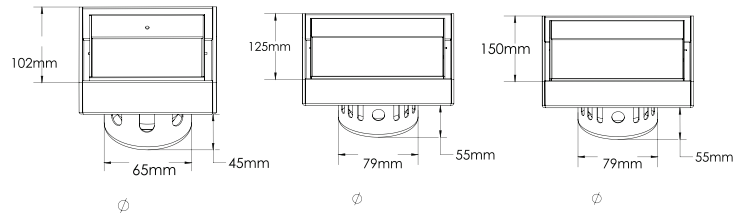

DAZZLE SQUARE TILE INSERT CHANNEL

Thickness 1.0 mm

| DIMENSIONS | | MRP (₹) |
|------------|-------------------|---------|
| Cat. Model | Overall Size (mm) | Matt |
| DSC 01 | 125 x 125 x 20 | 1,770 |
| DSC 02 | 150 x 150 x 20 | 2,120 |

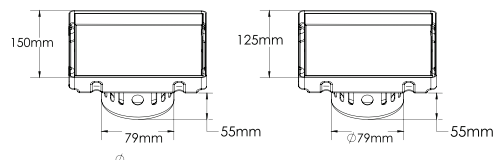

FLOOR DRAIN



AISI 304
18/8 STEEL

RUST
PROOF

LIFETIME
WARRANTY

GLOSS · MATT
FINISHES
ANTI-SCRATCH

100%
Non-Magnetic



KING (Floor Drain - Set of 4 pieces (In 2.5 mm thickness))



| DIMENSIONS | | MRP (₹) | |
|------------|-----------|---------|--|
| CAT. MODEL | Size (mm) | Matt | |
| KFD 01 | 102 x 102 | 2,060 | |
| KFD 01A | 125 x 125 | 2,470 | |
| KFD 01B | 150 x 150 | 2,840 | |

| DIMENSIONS | | MRP (₹) | |
|------------|-----------|---------|--|
| CAT. MODEL | Size (mm) | Matt | |
| KFD 02 | 102 x 102 | 2,060 | |
| KFD 02A | 125 x 125 | 2,470 | |
| KFD 02B | 150 x 150 | 2,840 | |

| DIMENSIONS | | MRP (₹) | |
|------------|-----------|---------|--|
| CAT. MODEL | Size (mm) | Matt | |
| KFD 03 | 102 x 102 | 2,320 | |
| KFD 03A | 125 x 125 | 2,860 | |
| KFD 03B | 150 x 150 | 3200 | |

| DIMENSIONS | | MRP (₹) | |
|------------|-----------|---------|--|
| CAT. MODEL | Size (mm) | Matt | |
| KFD 04 | 102 x 102 | 2,320 | |
| KFD 04A | 125 x 125 | 2,860 | |
| KFD 04B | 150 x 150 | 3200 | |

REGULAR (Floor Drain - Set of 4 pieces)



| DIMENSIONS | | MRP (₹) | | |
|------------|-----------|---------|------|--------------|
| CAT. MODEL | Size (mm) | Glossy | Matt | Anti-Scratch |
| RRB 80 | Ø 80 | 445 | 570 | 640 |
| RRB 102 | Ø 102 | 535 | 665 | 730 |
| RRB 127 | Ø 127 | 655 | 790 | 855 |

| DIMENSIONS | | MRP (₹) | | |
|------------|-----------|---------|------|--------------|
| CAT. MODEL | Size (mm) | Glossy | Matt | Anti-Scratch |
| RRB 80 H | Ø 80 | 495 | 625 | 690 |
| RRB 102 H | Ø 102 | 570 | 700 | 770 |
| RRB 127 H | Ø 127 | 705 | 840 | 910 |

| DIMENSIONS | | MRP (₹) | | |
|------------|-----------|---------|------|--------------|
| CAT. MODEL | Size (mm) | Glossy | Matt | Anti-Scratch |
| RRB 102 DP | Ø 102 | 535 | 665 | 730 |
| RRB 127 DP | Ø 127 | 655 | 790 | 855 |



| DIMENSIONS | | MRP (₹) | | |
|------------|-----------|---------|------|--------------|
| CAT. MODEL | Size (mm) | Glossy | Matt | Anti-Scratch |
| RRF 80 | Ø 80 | 445 | 570 | 640 |
| RRF 102 | Ø 102 | 535 | 665 | 730 |
| RRF 127 | Ø 127 | 655 | 790 | 855 |
| RRF 140 | Ø 140 | 770 | 905 | 1,030 |

| DIMENSIONS | | MRP (₹) | | |
|------------|-----------|---------|------|--------------|
| CAT. MODEL | Size (mm) | Glossy | Matt | Anti-Scratch |
| RRF 80 H | Ø 80 | 495 | 625 | 690 |
| RRF 102 H | Ø 102 | 570 | 700 | 770 |
| RRF 127 H | Ø 127 | 705 | 840 | 910 |
| RRF 140 H | Ø 140 | 820 | 950 | 1,080 |

| DIMENSIONS | | MRP (₹) | | |
|------------|-----------|---------|------|--------------|
| CAT. MODEL | Size (mm) | Glossy | Matt | Anti-Scratch |
| RRF 102 DP | Ø 102 | 535 | 665 | 730 |
| RRF 127 DP | Ø 127 | 655 | 790 | 855 |
| RRF 140 DP | Ø 140 | 770 | 905 | 1,030 |

CLASSIC Floor Drain - Set of 4 pieces



| DIMENSIONS | | MRP (₹) | | |
|------------|-----------|---------|------|--------------|
| CAT. MODEL | Size (mm) | Glossy | Matt | Anti-Scratch |
| CRB 127 | Ø 127 | 620 | 755 | 810 |



| DIMENSIONS | | MRP (₹) | | |
|------------|-----------|---------|------|--------------|
| CAT. MODEL | Size (mm) | Glossy | Matt | Anti-Scratch |
| CSB 127 | 127 x 127 | 685 | 810 | 880 |
| CSB 150 | 150 x 150 | 760 | 885 | 950 |



| DIMENSIONS | | MRP (₹) | | |
|------------|-----------|---------|------|--------------|
| CAT. MODEL | Size (mm) | Glossy | Matt | Anti-Scratch |
| CRF 127 | Ø 127 | 620 | 755 | 810 |
| CRF 140 | Ø 140 | 725 | 855 | 920 |



| DIMENSIONS | | MRP (₹) | | |
|------------|-----------|---------|------|--------------|
| CAT. MODEL | Size (mm) | Glossy | Matt | Anti-Scratch |
| CSF 127 | 127 x 127 | 685 | 810 | 880 |
| CSF 140 | 140 x 140 | 750 | 875 | 935 |
| CSF 150 | 150 x 150 | 760 | 885 | 950 |

REGULAR Floor Drain - Set of 4 pieces



| DIMENSIONS | | MRP (₹) | | |
|------------|-----------|---------|-------|--------------|
| CAT. MODEL | Size (mm) | Glossy | Matt | Anti-Scratch |
| RSB 80 | 80 x 80 | 525 | 650 | 720 |
| RSB 102 | 102 x 102 | 655 | 790 | 855 |
| RSB 127 | 127 x 127 | 770 | 905 | 1,030 |
| RSB 150 | 150 x 150 | 875 | 1,005 | 1,140 |



| DIMENSIONS | | MRP (₹) | | |
|------------|-----------|---------|-------|--------------|
| CAT. MODEL | Size (mm) | Glossy | Matt | Anti-Scratch |
| RSF 80 | 80 x 80 | 525 | 650 | 720 |
| RSF 102 | 102 x 102 | 655 | 790 | 920 |
| RSF 127 | 127 x 127 | 770 | 905 | 1,030 |
| RSF 140 | 140 x 140 | 835 | 960 | 1,095 |
| RSF 150 | 150 x 150 | 875 | 1,005 | 1,140 |



| DIMENSIONS | | MRP (₹) | | |
|------------|-----------|---------|-------|--------------|
| CAT. MODEL | Size (mm) | Glossy | Matt | Anti-Scratch |
| RSB 80 H | 80 x 80 | 600 | 725 | 790 |
| RSB 102 H | 102 x 102 | 705 | 840 | 910 |
| RSB 127 H | 127 x 127 | 820 | 950 | 1,080 |
| RSB 150 H | 150 x 150 | 945 | 1,075 | 1,210 |



| DIMENSIONS | | MRP (₹) | | |
|------------|-----------|---------|-------|--------------|
| CAT. MODEL | Size (mm) | Glossy | Matt | Anti-Scratch |
| RSF 80 H | 80 x 80 | 600 | 725 | 790 |
| RSF 102 H | 102 x 102 | 705 | 840 | 910 |
| RSF 127 H | 127 x 127 | 820 | 950 | 1,080 |
| RSF 140 H | 140 x 140 | 885 | 1,020 | 1,150 |
| RSF 150 H | 150 x 150 | 945 | 1,075 | 1,210 |



| DIMENSIONS | | MRP (₹) | | |
|------------|-----------|---------|-------|--------------|
| CAT. MODEL | Size (mm) | Glossy | Matt | Anti-Scratch |
| RSB 102 DP | 102 x 102 | 655 | 790 | 855 |
| RSB 127 DP | 127 x 127 | 770 | 905 | 1,030 |
| RSB 150 DP | 150 x 150 | 875 | 1,005 | 1,140 |



| DIMENSIONS | | MRP (₹) | | |
|------------|-----------|---------|-------|--------------|
| CAT. MODEL | Size (mm) | Glossy | Matt | Anti-Scratch |
| RSF 102 DP | 102 x 102 | 655 | 790 | 920 |
| RSF 127 DP | 127 x 127 | 770 | 905 | 1,030 |
| RSF 140 DP | 140 x 140 | 835 | 960 | 1,095 |
| RSF 150 DP | 150 x 150 | 875 | 1,005 | 1,140 |

FLORA Floor Drain - Set of 4 pieces



| DIMENSIONS | | MRP (₹) | |
|------------|-----------|---------|------|
| CAT. MODEL | Size (mm) | Glossy | Matt |
| FRB 127 | ∅ 127 | 795 | 925 |



| DIMENSIONS | | MRP (₹) | |
|------------|-----------|---------|-------|
| CAT. MODEL | Size (mm) | Glossy | Matt |
| FSB 127 | 127 x 127 | 930 | 1,065 |
| FSB 150 | 150 x 150 | 990 | 1,115 |



| DIMENSIONS | | MRP (₹) | |
|------------|-----------|---------|-------|
| CAT. MODEL | Size (mm) | Glossy | Matt |
| FRF 127 | ∅ 127 | 795 | 925 |
| FRF 140 | ∅ 140 | 930 | 1,065 |



| DIMENSIONS | | MRP (₹) | |
|------------|-----------|---------|-------|
| CAT. MODEL | Size (mm) | Glossy | Matt |
| FSF 127 | 127 x 127 | 930 | 1,065 |
| FSF 140 | 140 x 140 | 965 | 1,100 |
| FSF 150 | 150 x 150 | 990 | 1,115 |

NEON Floor Drain - Set of 4 pieces



| DIMENSIONS | | MRP (₹) | | |
|------------|-----------|---------|------|--------------|
| CAT. MODEL | Size (mm) | Glossy | Matt | Anti-Scratch |
| NRB 102 | ∅ 102 | 705 | 840 | - |
| NRB 127 | ∅ 127 | 795 | 925 | - |



| DIMENSIONS | | MRP (₹) | | |
|------------|-----------|---------|-------|--------------|
| CAT. MODEL | Size (mm) | Glossy | Matt | Anti-Scratch |
| NRF 102 | ∅ 102 | 705 | 840 | 965 |
| NRF 127 | ∅ 127 | 795 | 925 | 1,060 |
| NRF 140 | ∅ 140 | 895 | 1,025 | 1,155 |



| DIMENSIONS | | MRP (₹) | | |
|------------|-----------|---------|-------|--------------|
| CAT. MODEL | Size (mm) | Glossy | Matt | Anti-Scratch |
| NSB 102 | 102 x 102 | 795 | 925 | - |
| NSB 127 | 127 x 127 | 930 | 1,065 | - |
| NSB 150 | 150 x 150 | 990 | 1,115 | - |



| DIMENSIONS | | MRP (₹) | | |
|------------|-----------|---------|-------|--------------|
| CAT. MODEL | Size (mm) | Glossy | Matt | Anti-Scratch |
| NSF 102 | 102 x 102 | 795 | 925 | 1,060 |
| NSF 127 | 127 x 127 | 930 | 1,065 | 1,325 |
| NSF 140 | 140 x 140 | 965 | 1,100 | 1,365 |
| NSF 150 | 150 x 150 | 990 | 1,115 | 1,380 |



| DIMENSIONS | | MRP (₹) | | |
|------------|-----------|---------|-------|--------------|
| CAT. MODEL | Size (mm) | Glossy | Matt | Anti-Scratch |
| ERF 127 | Ø 127 | 1,205 | 1,370 | 1,620 |
| ERF 140 | Ø 140 | 1,305 | 1,430 | 1,695 |



| DIMENSIONS | | MRP (₹) | | |
|------------|-----------|---------|-------|--------------|
| CAT. MODEL | Size (mm) | Glossy | Matt | Anti-Scratch |
| ESF 127 | 127 x 127 | 1,295 | 1,420 | 1,685 |
| ESF 140 | 140 x 140 | 1,350 | 1,485 | 1,740 |
| ESF 150 | 150 x 150 | 1,385 | 1,530 | 1,790 |

PREMIUM Floor Drain - Set of 4 pieces



| DIMENSIONS | | MRP (₹) | | |
|------------|-----------|---------|-------|--------------|
| CAT. MODEL | Size (mm) | Glossy | Matt | Anti-Scratch |
| PRF 127 | Ø 127 | 795 | 925 | 1,060 |
| PRF 140 | Ø 140 | 895 | 1,025 | 1,155 |



| DIMENSIONS | | MRP (₹) | | |
|------------|-----------|---------|------|--------------|
| CAT. MODEL | Size (mm) | Glossy | Matt | Anti-Scratch |
| PRB 127 | Ø 127 | 795 | 925 | 1,060 |



| DIMENSIONS | | MRP (₹) | | |
|------------|-----------|---------|-------|--------------|
| CAT. MODEL | Size (mm) | Glossy | Matt | Anti-Scratch |
| PSB 127 | 127 x 127 | 930 | 1,065 | 1,325 |
| PSB 150 | 150 x 150 | 990 | 1,115 | 1,380 |



| DIMENSIONS | | MRP (₹) | | |
|------------|-----------|---------|-------|--------------|
| CAT. MODEL | Size (mm) | Glossy | Matt | Anti-Scratch |
| PSF 127 | 127 x 127 | 930 | 1,065 | 1,325 |
| PSF 140 | 140 x 140 | 965 | 1,100 | 1,365 |
| PSF 150 | 150 x 150 | 990 | 1,115 | 1,380 |

ASPIRE Pop up series floor drain - Set of 4 pieces



| DIMENSIONS | | MRP (₹) | | |
|------------|-----------|---------|-------|--------------|
| CAT. MODEL | Size (mm) | Glossy | Matt | Anti-Scratch |
| ARB 127 | Ø 127 | 1,795 | 1,925 | 2,185 |



| DIMENSIONS | | MRP (₹) | | |
|------------|-----------|---------|-------|--------------|
| CAT. MODEL | Size (mm) | Glossy | Matt | Anti-Scratch |
| ASF 127 | 127 x 127 | 2,000 | 2,130 | 2,390 |
| ASF 140 | 140 x 140 | 2,055 | 2,185 | 2,450 |
| ASF 150 | 150 x 150 | 2,120 | 2,255 | 2,515 |



| DIMENSIONS | | MRP (₹) | | |
|------------|-----------|---------|-------|--------------|
| CAT. MODEL | Size (mm) | Glossy | Matt | Anti-Scratch |
| ARF 127 | Ø 127 | 1,795 | 1,925 | 2,185 |
| ARF 140 | Ø 140 | 1,840 | 1,965 | 2,230 |



Floor Drain cover in Aspire comes with Push and Pull mechanism.

It can easily be open or shut with a gentle push by foot on the cover.

MAGIC Water free series floor drain - Set of 4 pieces



| DIMENSIONS | | MRP (₹) | | |
|------------|-----------|---------|------|--------------|
| CAT. MODEL | Size (mm) | Glossy | Matt | Anti-Scratch |
| MRF 127 | Ø 127 | 725 | 855 | 990 |
| MRF 140 | Ø 140 | 795 | 925 | 1,060 |



| DIMENSIONS | | MRP (₹) | | |
|------------|-----------|---------|------|--------------|
| CAT. MODEL | Size (mm) | Glossy | Matt | Anti-Scratch |
| MSB 127 | 127 x 127 | 725 | 855 | 990 |
| MSB 150 | 150 x 150 | 820 | 950 | 1,080 |



| DIMENSIONS | | MRP (₹) | | |
|------------|-----------|---------|------|--------------|
| CAT. MODEL | Size (mm) | Glossy | Matt | Anti-Scratch |
| MSF 127 | 127 x 127 | 725 | 855 | 990 |
| MSF 140 | 140 x 140 | 795 | 925 | 1,060 |
| MSF 150 | 150 x 150 | 820 | 950 | 1,080 |



The auto lock floor drain that works on 6th sense. Auto locking system operates with the pressure of water and closes when not in use.

GARNET Water free series floor drain - Set of 3 pieces



| DIMENSIONS | | MRP (₹) | | |
|------------|-----------|---------|------|--------------|
| CAT. MODEL | Size (mm) | Glossy | Matt | Anti-Scratch |
| GSF 102 | 102 x 102 | 675 | 800 | 930 |
| GSF 127 | 127 x 127 | 725 | 855 | 990 |
| GSF 140 | 140 x 140 | 795 | 925 | 1,060 |
| GSF 150 | 150 x 150 | 820 | 950 | 1,080 |

| DIMENSIONS | | MRP (₹) | | |
|------------|-----------|---------|------|--------------|
| CAT. MODEL | Size (mm) | Glossy | Matt | Anti-Scratch |
| GSB 102 | 102 x 102 | 635 | 765 | 895 |
| GSB 127 | 127 x 127 | 685 | 810 | 945 |

LOTUS Water free series floor drain - Set of 3 pieces



| DIMENSIONS | | MRP (₹) | | |
|------------|-----------|---------|------|--------------|
| CAT. MODEL | Size (mm) | Glossy | Matt | Anti-Scratch |
| LSF 102 | 102 x 102 | 675 | 800 | 930 |
| LSF 127 | 127 x 127 | 725 | 855 | 990 |
| LSF 140 | 140 x 140 | 795 | 925 | 1,060 |
| LSF 150 | 150 x 150 | 820 | 950 | 1,080 |

| DIMENSIONS | | MRP (₹) | | |
|------------|-----------|---------|------|--------------|
| CAT. MODEL | Size (mm) | Glossy | Matt | Anti-Scratch |
| LSB 102 | 102 x 102 | 635 | 765 | 895 |
| LSB 127 | 127 x 127 | 685 | 810 | 945 |

WONDER Floor Drain - Set of 4 pieces (Frame 1.0 mm / Gratings 1.5 mm)



| DIMENSIONS | | MRP (₹) |
|------------|-----------|---------|
| CAT. MODEL | Size (mm) | Matt |
| WSF 01 | 127 x 127 | 1,115 |
| WSF 01A | 150 x 150 | 1,220 |

| DIMENSIONS | | MRP (₹) |
|------------|-----------|---------|
| CAT. MODEL | Size (mm) | Matt |
| WSF 02 | 127 x 127 | 1,115 |
| WSF 02A | 150 x 150 | 1,220 |

| DIMENSIONS | | MRP (₹) |
|------------|-----------|---------|
| CAT. MODEL | Size (mm) | Matt |
| WSF 03 | 127 x 127 | 1,115 |
| WSF 03A | 150 x 150 | 1,220 |

WONDER Gratings with Square frame - Set of 2 pieces (Frame 1.0 mm / Gratings 1.5 mm)



| DIMENSIONS | | MRP (₹) |
|------------|-----------|---------|
| CAT. MODEL | Size (mm) | Matt |
| WSG 01 | 127 x 127 | 730 |
| WSG 01A | 150 x 150 | 835 |

| DIMENSIONS | | MRP (₹) |
|------------|-----------|---------|
| CAT. MODEL | Size (mm) | Matt |
| WSG 02 | 127 x 127 | 730 |
| WSG 02A | 150 x 150 | 835 |

| DIMENSIONS | | MRP (₹) |
|------------|-----------|---------|
| CAT. MODEL | Size (mm) | Matt |
| WSG 03 | 127 x 127 | 730 |
| WSG 03A | 150 x 150 | 835 |

RAIN ROOF DRAINER - Set of 3 pieces



| CAT. MODEL | DIMENSIONS Size (mm) | MRP (₹) | |
|------------|-------------------------|---------|-------|
| | | Glossy | Matt |
| JSB 127 | 127 x 127 | 1,110 | 1,295 |
| JSB 150 | 150 x 150 | 1,240 | 1,375 |



| CAT. MODEL | DIMENSIONS Size (mm) | MRP (₹) | |
|------------|-------------------------|---------|-------|
| | | Glossy | Matt |
| JSF 127 | 127 x 127 | 1,110 | 1,295 |
| JSF 140 | 140 x 140 | 1,210 | 1,335 |
| JSF 150 | 150 x 150 | 1,240 | 1,375 |



| CAT. MODEL | DIMENSIONS Size (mm) | MRP (₹) | |
|------------|-------------------------|---------|-------|
| | | Glossy | Matt |
| JRF 127 | ∅ 127 | 1,030 | 1,160 |
| JRF 140 | ∅ 140 | 1,120 | 1,255 |



NEW

| CAT. MODEL | DIMENSIONS Size (mm) | MRP (₹) | |
|------------|-------------------------|---------|------|
| | | Glossy | Matt |
| JRD 01 | 102 x 102 x 102 | | 435 |
| JRD 02 | 127 x 127 x 127 | | 530 |

(In 1.5 mm thickness)

CLEAN OUT Set of 2 pieces 1mm thickness



| CAT. MODEL | DIMENSIONS Size (mm) | MRP (₹) | |
|------------|-------------------------|---------|------|
| | | Glossy | Matt |
| COR 102 | ∅ 102 | 485 | 615 |
| COR 127 | ∅ 127 | 535 | 665 |
| COR 140 | ∅ 140 | 570 | 700 |



| CAT. MODEL | DIMENSIONS Size (mm) | MRP (₹) | |
|------------|-------------------------|---------|------|
| | | Glossy | Matt |
| COS 102 | 102 x 102 | 510 | 640 |
| COS 127 | 127 x 127 | 560 | 690 |
| COS 140 | 140 x 140 | 605 | 730 |
| COS 150 | 150 x 150 | 665 | 795 |

CLEAN OUT HEAVY 1.5mm thickness



| CAT. MODEL | DIMENSIONS Size (mm) | MRP (₹) | |
|------------------|-------------------------|---------|------|
| | | Glossy | Matt |
| COH 127 | 127 x 127 | 760 | 870 |
| 1.5 mm thickness | | | |
| COH 140 | 140 x 140 | 840 | 960 |
| 1.5 mm thickness | | | |
| COH 150 | 150 x 150 | 895 | 1020 |
| 1.5 mm thickness | | | |

CLEAN OUT BIG Set of 2 pieces



| CAT. MODEL | DIMENSIONS Size (mm) | MRP (₹) | |
|------------|-------------------------|---------|-------|
| | | Glossy | Matt |
| COB 150 | 150 x 150 | | 1,955 |
| COB 200 | 200 x 200 | | 2,480 |
| COB 250 | 250 x 250 | | 3,130 |

GRATINGS With frame - Set of 2 pieces



| CAT. MODEL | DIMENSIONS Size (mm) | MRP (₹) | | |
|------------|-------------------------|---------|------|--------------|
| | | Glossy | Matt | Anti-Scratch |
| ERG 127 | ∅ 127 | 735 | 865 | 1,070 |
| ERG 140 | ∅ 140 | 805 | 935 | 1,140 |



| CAT. MODEL | DIMENSIONS Size (mm) | MRP (₹) | | |
|------------|-------------------------|---------|-------|--------------|
| | | Glossy | Matt | Anti-Scratch |
| ESG 127 | 127 x 127 | 820 | 950 | 1,215 |
| ESG 140 | 140 x 140 | 855 | 990 | 1,250 |
| ESG 150 | 150 x 150 | 895 | 1,025 | 1,290 |

GRATINGS 1 piece



| CAT. MODEL | DIMENSIONS Size (mm) | MRP (₹) | | |
|------------|-------------------------|---------|------|--------------|
| | | Glossy | Matt | Anti-Scratch |
| NG 82 R | ∅ 82 | 230 | 280 | 360 |
| NG 104 R | ∅ 104 | 255 | 305 | 385 |



| CAT. MODEL | DIMENSIONS Size (mm) | MRP (₹) | | |
|------------|-------------------------|---------|------|--------------|
| | | Glossy | Matt | Anti-Scratch |
| R 52 | ∅ 52 | 125 | 175 | 205 |
| R 64 | ∅ 64 | 165 | 225 | 245 |
| R 82 | ∅ 82 | 205 | 255 | 280 |
| R 104 | ∅ 104 | 230 | 280 | 305 |



| DIMENSIONS | | MRP (₹) | | |
|------------|-----------|---------|------|--------------|
| CAT. MODEL | Size (mm) | Glossy | Matt | Anti-Scratch |
| RRG 80 | Ø 80 | 225 | 275 | 355 |
| RRG 102 | Ø 102 | 275 | 330 | 405 |
| RRG 127 | Ø 127 | 330 | 380 | 460 |
| RRG 140 | Ø 140 | 405 | 460 | 535 |



| DIMENSIONS | | MRP (₹) | | |
|------------|-----------|---------|------|--------------|
| CAT. MODEL | Size (mm) | Glossy | Matt | Anti-Scratch |
| RRG 102 H | Ø 102 | 320 | 380 | 455 |
| RRG 127 H | Ø 127 | 380 | 430 | 510 |
| RRG 140 H | Ø 140 | 455 | 510 | 585 |



| DIMENSIONS | | MRP (₹) | | |
|------------|-----------|---------|------|--------------|
| CAT. MODEL | Size (mm) | Glossy | Matt | Anti-Scratch |
| RRG 102 DP | Ø 102 | 275 | 330 | 405 |
| RRG 127 DP | Ø 127 | 330 | 380 | 460 |
| RRG 140 DP | Ø 140 | 405 | 460 | 535 |



| DIMENSIONS | | MRP (₹) | | |
|------------|-----------|---------|------|--------------|
| CAT. MODEL | Size (mm) | Glossy | Matt | Anti-Scratch |
| NRG 102 | Ø 102 | 330 | 380 | 460 |
| NRG 127 | Ø 127 | 420 | 475 | 550 |
| NRG 140 | Ø 140 | 445 | 495 | 570 |



| DIMENSIONS | | MRP (₹) | | |
|------------|-----------|---------|------|--------------|
| CAT. MODEL | Size (mm) | Glossy | Matt | Anti-Scratch |
| NRG 102 H | Ø 102 | 380 | 430 | 510 |
| NRG 127 H | Ø 127 | 470 | 530 | 605 |
| NRG 140 H | Ø 140 | 490 | 545 | 620 |



| DIMENSIONS | | MRP (₹) | | |
|------------|----------------|---------|------|--------------|
| CAT. MODEL | Bowl Size (mm) | Glossy | Matt | Anti-Scratch |
| RSG 80 | 80 x 80 | 245 | 300 | 355 |
| RSG 102 | 102 x 102 | 310 | 370 | 405 |
| RSG 127 | 127 x 127 | 385 | 435 | 465 |
| RSG 140 | 140 x 140 | 415 | 470 | 495 |
| RSG 150 | 150 x 150 | 450 | 500 | 530 |



| DIMENSIONS | | MRP (₹) | | |
|------------|-----------|---------|------|--------------|
| CAT. MODEL | Size (mm) | Glossy | Matt | Anti-Scratch |
| RSG 102 H | 102 x 102 | 360 | 415 | 455 |
| RSG 127 H | 127 x 127 | 435 | 485 | 520 |
| RSG 150 H | 150 x 150 | 495 | 550 | 575 |



| DIMENSIONS | | MRP (₹) | | |
|------------|-----------|---------|------|--------------|
| CAT. MODEL | Size (mm) | Glossy | Matt | Anti-Scratch |
| RSG 102 DP | 102 x 102 | 310 | 370 | 405 |
| RSG 127 DP | 127 x 127 | 385 | 435 | 465 |
| RSG 140 DP | 140 x 140 | 415 | 470 | 495 |
| RSG 150 DP | 150 x 150 | 450 | 500 | 530 |



| DIMENSIONS | | MRP (₹) | | |
|------------|-----------|---------|------|--------------|
| CAT. MODEL | Size (mm) | Glossy | Matt | Anti-Scratch |
| NSG 102 | 102 x 102 | 470 | 525 | 605 |
| NSG 127 | 127 x 127 | 490 | 540 | 620 |
| NSG 140 | 140 x 140 | 560 | 615 | 690 |
| NSG 150 | 150 x 150 | 590 | 640 | 720 |



| DIMENSIONS | | MRP (₹) | | |
|------------|-----------|---------|------|--------------|
| CAT. MODEL | Size (mm) | Glossy | Matt | Anti-Scratch |
| NSG 102 H | 102 x 102 | 525 | 570 | 650 |
| NSG 127 H | 127 x 127 | 540 | 590 | 675 |
| NSG 150 H | 150 x 150 | 640 | 690 | 770 |



| DIMENSIONS | | MRP (₹) | | |
|------------|-----------|---------|------|--------------|
| CAT. MODEL | Size (mm) | Glossy | Matt | Anti-Scratch |
| PRG 127 | Ø 127 | 420 | 470 | 550 |
| PRG 140 | Ø 140 | 445 | 495 | 570 |



| DIMENSIONS | | MRP (₹) | | |
|------------|-----------|---------|------|--------------|
| CAT. MODEL | Size (mm) | Glossy | Matt | Anti-Scratch |
| PSG 127 | 127 x 127 | 470 | 525 | 605 |
| PSG 140 | 140 x 140 | 490 | 540 | 620 |
| PSG 150 | 150 x 150 | 510 | 560 | 640 |

TOPAZ Gratings with beeding & frame - Set of 2 pieces



| DIMENSIONS | | MRP (₹) | |
|------------|-----------|---------|------|
| CAT. MODEL | Size (mm) | Glossy | Matt |
| TR 102 | Ø 102 | 275 | 320 |
| TR 127 | Ø 127 | 295 | 340 |
| TR 140 | Ø 140 | 335 | 385 |



| DIMENSIONS | | MRP (₹) | |
|------------|-----------|---------|------|
| CAT. MODEL | Size (mm) | Glossy | Matt |
| TR 102 DP | Ø 102 | 275 | 320 |
| TR 127 DP | Ø 127 | 295 | 340 |
| TR 140 DP | Ø 140 | 335 | 385 |



| DIMENSIONS | | MRP (₹) | |
|------------|-----------|---------|------|
| CAT. MODEL | Size (mm) | Glossy | Matt |
| TR 102 H | Ø 102 | 310 | 360 |
| TR 127 H | Ø 127 | 345 | 395 |
| TR 140 H | Ø 140 | 405 | 455 |



| DIMENSIONS | | MRP (₹) | |
|-------------|-----------|---------|------|
| CAT. MODEL | Size (mm) | Glossy | Matt |
| TR 102 DP H | Ø 102 | 310 | 360 |
| TR 127 DP H | Ø 127 | 345 | 395 |
| TR 140 DP H | Ø 140 | 405 | 455 |



| DIMENSIONS | | MRP (₹) | |
|------------|-----------|---------|------|
| CAT. MODEL | Size (mm) | Glossy | Matt |
| TS 102 | 102 x 102 | 310 | 360 |
| TS 127 | 127 x 127 | 370 | 415 |
| TS 140 | 140 x 140 | 410 | 460 |
| TS 150 | 150 x 150 | 435 | 510 |



| DIMENSIONS | | MRP (₹) | |
|------------|-----------|---------|------|
| CAT. MODEL | Size (mm) | Glossy | Matt |
| TS 102 DP | 102 x 102 | 310 | 360 |
| TS 127 DP | 127 x 127 | 370 | 415 |
| TS 140 DP | 140 x 140 | 410 | 460 |
| TS 150 DP | 150 x 150 | 435 | 510 |



| DIMENSIONS | | MRP (₹) | |
|------------|-----------|---------|------|
| CAT. MODEL | Size (mm) | Glossy | Matt |
| TS 102 H | 102 x 102 | 345 | 395 |
| TS 127 H | 127 x 127 | 410 | 460 |
| TS 140 H | 140 x 140 | 450 | 495 |
| TS 150 H | 150 x 150 | 470 | 525 |



| DIMENSIONS | | MRP (₹) | |
|-------------|-----------|---------|------|
| CAT. MODEL | Size (mm) | Glossy | Matt |
| TS 102 DP H | 102 x 102 | 345 | 395 |
| TS 127 DP H | 127 x 127 | 410 | 460 |
| TS 140 DP H | 140 x 140 | 450 | 495 |
| TS 150 DP H | 150 x 150 | 470 | 525 |

GRATINGS With LID & NOB - Set of 3 pieces.



| CAT. MODEL | DIMENSIONS Size (mm) | MRP (₹) | | |
|------------|-------------------------|---------|------|--------------|
| | | Glossy | Matt | Anti-Scratch |
| LR 01 | ∅ 127 | 470 | 525 | 605 |
| LR 02 | ∅ 140 | 510 | 560 | 640 |

| CAT. MODEL | DIMENSIONS Size (mm) | MRP (₹) | | |
|------------|-------------------------|---------|------|--------------|
| | | Glossy | Matt | Anti-Scratch |
| LS 01 | 127 x 127 | 535 | 590 | 665 |
| LS 02 | 140 x 140 | 560 | 615 | 690 |
| LS 03 | 150 x 150 | 590 | 640 | 720 |

TOPAZ GOLD Gratings with frame - Set of 2 pieces - Flat cut



| CAT. MODEL | DIMENSIONS Size (mm) | MRP (₹) | |
|------------|-------------------------|---------|------|
| | | Glossy | Matt |
| TGR 127 | ∅ 127 | 310 | 360 |
| TGR 140 | ∅ 140 | 345 | 395 |

| CAT. MODEL | DIMENSIONS Size (mm) | MRP (₹) | |
|------------|-------------------------|---------|------|
| | | Glossy | Matt |
| TGR 127 H | ∅ 127 | 355 | 405 |
| TGR 140 H | ∅ 140 | 405 | 460 |

| CAT. MODEL | DIMENSIONS Size (mm) | MRP (₹) | |
|------------|-------------------------|---------|------|
| | | Glossy | Matt |
| TGR 127 DP | ∅ 127 | 310 | 360 |
| TGR 140 DP | ∅ 140 | 345 | 395 |



| CAT. MODEL | DIMENSIONS Size (mm) | MRP (₹) | |
|--------------|-------------------------|---------|------|
| | | Glossy | Matt |
| TGR 127 DP H | ∅ 127 | 355 | 405 |
| TGR 140 DP H | ∅ 140 | 405 | 460 |

| CAT. MODEL | DIMENSIONS Size (mm) | MRP (₹) | |
|------------|-------------------------|---------|------|
| | | Glossy | Matt |
| TGS 127 | 127 x 127 | 360 | 410 |
| TGS 140 | 140 x 140 | 405 | 460 |
| TGS 150 | 150 x 150 | 420 | 475 |

| CAT. MODEL | DIMENSIONS Size (mm) | MRP (₹) | |
|------------|-------------------------|---------|------|
| | | Glossy | Matt |
| TGS 127 DP | 127 x 127 | 360 | 410 |
| TGS 140 DP | 140 x 140 | 405 | 460 |
| TGS 150 DP | 150 x 150 | 420 | 475 |



| CAT. MODEL | DIMENSIONS Size (mm) | MRP (₹) | |
|------------|-------------------------|---------|------|
| | | Glossy | Matt |
| TGS 127 H | 127 x 127 | 420 | 475 |
| TGS 140 H | 140 x 140 | 470 | 525 |
| TGS 150 H | 150 x 150 | 525 | 570 |

| CAT. MODEL | DIMENSIONS Size (mm) | MRP (₹) | |
|--------------|-------------------------|---------|------|
| | | Glossy | Matt |
| TGS 127 DP H | 127 x 127 | 420 | 475 |
| TGS 140 DP H | 140 x 140 | 470 | 525 |
| TGS 150 DP H | 150 x 150 | 525 | 570 |

NEW HEAVY GRATINGS (In 1.5 mm Thickness) Set of 3 pcs.

NEW HEAVY GRATINGS (In 1.5 mm Thickness) Set of 2 pcs.



| CAT. MODEL | DIMENSIONS Size (mm) | MRP (₹) |
|-------------|-------------------------|---------|
| | | Matt |
| NHG 140 (A) | 140 x 140 | 1,020 |
| NHG 150 (A) | 150 x 150 | 1,080 |

| CAT. MODEL | DIMENSIONS Size (mm) | MRP (₹) | |
|------------|-------------------------|---------|-------|
| | | Glossy | Matt |
| NHG 140 | 140 x 140 | 840 | 960 |
| NHG 150 | 150 x 150 | 895 | 1,020 |



| DIMENSIONS | | MRP (₹) | |
|------------|-----------|---------|------|
| CAT. MODEL | Size (mm) | Glossy | Matt |
| OR 60 | Ø 60 | 140 | 185 |
| OR 80 | Ø 80 | 175 | 225 |
| OR 102 | Ø 102 | 215 | 260 |
| OR 114 | Ø 114 | 240 | 290 |
| OR 127 | Ø 127 | 245 | 290 |

| DIMENSIONS | | MRP (₹) | |
|------------|-----------|---------|------|
| CAT. MODEL | Size (mm) | Glossy | Matt |
| OR 80 DP | Ø 80 | 175 | 225 |
| OR 102 DP | Ø 102 | 215 | 260 |
| OR 114 DP | Ø 114 | 240 | 290 |
| OR 127 DP | Ø 127 | 245 | 290 |

| DIMENSIONS | | MRP (₹) | |
|------------|-----------|---------|------|
| CAT. MODEL | Size (mm) | Glossy | Matt |
| OS 60 | 60 x 60 | 145 | 200 |
| OS 80 | 80 x 80 | 180 | 235 |
| OS 102 | 102 x 102 | 225 | 275 |
| OS 127 | 127 x 127 | 260 | 310 |
| OS 140 | 140 x 140 | 280 | 330 |
| OS 150 | 150 x 150 | 290 | 345 |



| DIMENSIONS | | MRP (₹) | |
|------------|-----------|---------|------|
| CAT. MODEL | Size (mm) | Glossy | Matt |
| OS 80 DP | 80 x 80 | 180 | 235 |
| OS 102 DP | 102 x 102 | 225 | 275 |
| OS 127 DP | 127 x 127 | 260 | 310 |
| OS 140 DP | 140 x 140 | 280 | 330 |
| OS 150 DP | 150 x 150 | 290 | 345 |

OPAL GOLD Gratings -1 piece - Flat cut



| DIMENSIONS | | MRP (₹) | |
|------------|-----------|---------|------|
| CAT. MODEL | Size (mm) | Glossy | Matt |
| ORG 01 | Ø 102 | 240 | 290 |
| ORG 02 | Ø 114 | 250 | 300 |
| ORG 03 | Ø 127 | 280 | 325 |

| DIMENSIONS | | MRP (₹) | |
|------------|-----------|---------|------|
| CAT. MODEL | Size (mm) | Glossy | Matt |
| ORG 01 DP | Ø 102 | 240 | 290 |
| ORG 02 DP | Ø 114 | 250 | 300 |
| ORG 03 DP | Ø 127 | 280 | 325 |

| DIMENSIONS | | MRP (₹) | |
|------------|-----------|---------|------|
| CAT. MODEL | Size (mm) | Glossy | Matt |
| OSG 102 | 102 x 102 | 250 | 300 |
| OSG 127 | 127 x 127 | 290 | 345 |
| OSG 140 | 140 x 140 | 335 | 385 |
| OSG 150 | 150 x 150 | 380 | 430 |



| DIMENSIONS | | MRP (₹) | |
|------------|-----------|---------|------|
| CAT. MODEL | Size (mm) | Glossy | Matt |
| OSG 102 DP | 102 x 102 | 250 | 300 |
| OSG 127 DP | 127 x 127 | 290 | 345 |
| OSG 140 DP | 140 x 140 | 335 | 385 |
| OSG 150 DP | 150 x 150 | 380 | 430 |

INDUS KING



| DIMENSIONS | | MRP (₹) | |
|------------|-----------|---------|-------|
| CAT. MODEL | Size (mm) | Glossy | Matt |
| IK 190 | 190 x 190 | 6,435 | 6,550 |

MANHOLE COVER



Manhole Cover

BENEFITS OF SS MANHOLE COVERS:

- Convenient to installation and inspection.
- Overcomes the problem of ringing of the original Manhole cover.
- SS Manhole covers are corrosion resistant. It is not only moisture proof, acid and alkali resistant but also a long service providing product.

Made from high grade AISI-304 (18/8) Stainless Steel (18% Chrome, 8% Nickel)

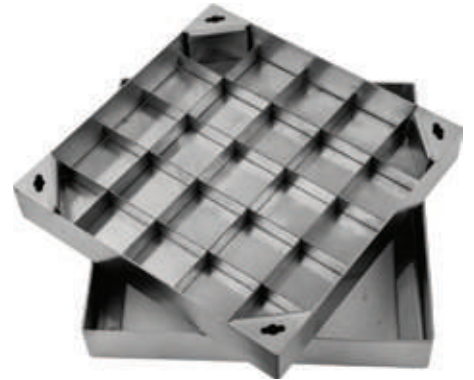

| CAT. MODEL | DIMENSIONS | | MRP (₹) |
|---|----------------------|----------------------|---------|
| | Inner Size (inch/mm) | Outer Size (inch/mm) | Matt |
| MHC 01 Base Frame : 1.5 mm Cover : 1.2 mm | 10 x 10 255 x 255 | 12 x 12 305 x 305 | 7,700 |
| MHC 01 A Base Frame : 1.5 mm Cover : 1.2 mm | 14 x 14 360 x 360 | 16 x 16 410 x 410 | 9,900 |
| MHC 02 Base Frame : 1.5 mm Cover : 1.2 mm | 16 x 16 410 x 410 | 18 x 18 460 x 460 | 11,660 |
| MHC 02 A Base Frame : 2.5 mm Cover : 1.5 mm | 20 x 20 510 x 510 | 22 x 22 560 x 560 | 13,750 |
| MHC 03 Base Frame : 2.5 mm Cover : 1.5 mm | 22 x 22 560 x 560 | 24 x 24 610 x 610 | 14,850 |
| MHC 04 Base Frame : 2.5 mm Cover : 1.5 mm | 24 x 24 610 x 610 | 26 x 26 660 x 660 | 17,050 |
| MHC 04 A Base Frame : 2.5 mm Cover : 1.5 mm | 26 x 26 660 x 660 | 28 x 28 710 x 710 | 17,600 |
| MHC 05 Base Frame : 2.5 mm Cover : 1.5 mm | 28 x 28 710 x 710 | 30 x 30 760x 760 | 18,150 |

* Customisation possible of any size on request.

HYDRO Vertical Grating -1 piece



| CAT. MODEL | DIMENSIONS | MRP (₹) |
|------------|------------|---------|
| | Size (mm) | Matt |
| HR 01 | 150 x 600 | 2,890 |
| HR 02 | 200 x 600 | 3,675 |
| HR 03 | 300 x 600 | 4,720 |

| CAT. MODEL | DIMENSIONS | MRP (₹) |
|------------|------------|---------|
| | Size (mm) | Matt |
| HR 04 | 102 x 102 | 385 |
| HR 05 | 102 x 150 | 495 |
| HR 06 | 102 x 200 | 635 |
| HR 07 | 102 x 300 | 885 |

| CAT. MODEL | DIMENSIONS | | MRP (₹) |
|------------|------------|-----------|---------|
| | Thickness | Size (mm) | Matt |
| HS 01 | 1mm | 80 x 80 | 235 |
| HS 02 | 1mm | 106 x 106 | 315 |
| HS 03 | 1.2mm | 130 x 130 | 405 |
| HS 04 | 1.2mm | 150 x 150 | 510 |
| HS 05 | 1.5mm | 200 x 200 | 1,155 |
| HS 06 | 1.5mm | 250 x 250 | 1,660 |
| HS 07 | 1.5mm | 300 x 300 | 2,275 |

HYDRO Vertical Grating with frame -2 pieces

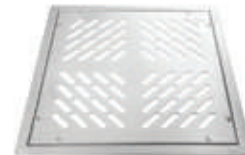

| CAT. MODEL | DIMENSIONS | MRP (₹) |
|------------|------------|---------|
| | Size (mm) | Matt |
| HRF 01 | 150 x 600 | 4,065 |
| HRF 02 | 200 x 600 | 5,245 |
| HRF 03 | 300 x 600 | 6,470 |

| CAT. MODEL | DIMENSIONS | MRP (₹) |
|------------|------------|---------|
| | Size (mm) | Matt |
| HSF 05 | 200 x 200 | 3,150 |
| HSF 06 | 250 x 250 | 3,675 |
| HSF 07 | 300 x 300 | 4,200 |

RAIN WATER DRAINAGE COVER Thickness: Cover 1.5mm, Frame 2.5mm.



| CAT. MODEL | DIMENSIONS | | MRP (₹) |
|------------|----------------------|----------------------|---------|
| | Inner Size (inch/mm) | Outer Size (inch/mm) | Matt |
| RWD 01 | 09 x 09 225 x 225 | 11 x 11 280 x 280 | 5,150 |
| RWD 02 | 12 x 12 305 x 305 | 14 x 14 350 x 350 | 6,275 |

| CAT. MODEL | DIMENSIONS | | MRP (₹) |
|------------|----------------------|----------------------|---------|
| | Inner Size (inch/mm) | Outer Size (inch/mm) | Matt |
| RWC 01 | 09 x 09 225 x 225 | 11 x 11 280 x 280 | 5,150 |
| RWC 02 | 12 x 12 305 x 305 | 14 x 14 350 x 350 | 6,275 |



ACCESS COVER Thickness: Cover 1.2mm, Frame 1.0mm.

NEW



| CAT. MODEL | DIMENSIONS | | MRP (₹) |
|------------|----------------------|----------------------|---------|
| | Inner Size (inch/mm) | Outer Size (inch/mm) | Matt |
| AC 01 | 09 x 09 225 x 225 | 11 x 11 280 x 280 | 3,790 |
| AC 02 | 12 x 12 305 x 305 | 14 x 14 350 x 350 | 4,820 |

BOX CHANNEL

NEW



| CAT. MODEL | DIMENSIONS | MRP (₹) |
|---------------------------|------------|---------|
| | Size (mm) | Matt |
| BC 01 (Vertical Outlet) | 330 x 330 | 13,040 |
| BC 02 (Horizontal Outlet) | 330 x 330 | 13,040 |

| CAT. MODEL | DIMENSIONS | MRP (₹) |
|---------------------------|------------|---------|
| | Size (mm) | Matt |
| BC 03 (Vertical Outlet) | 330 x 330 | 6,830 |
| BC 04 (Horizontal Outlet) | 330 x 330 | 6,830 |
| BC 05 (Horizontal Outlet) | 300 x 600 | 11,800 |
| BC 06 (Horizontal Outlet) | 300 x 1000 | 16,765 |

With anti-skid gate and outlet 4"



With normal grate and outlet 4"

PVC ACCESSORIES

NEW



| BOTTLE TRAP | |
|-------------|-------|
| CAT. MODEL | M.R.P |
| BT 01 | 805 |

* Ø 1-1/2 inch inlet & Ø 40 mm outlet



| BOTTLE TRAP | |
|-------------|-------|
| CAT. MODEL | M.R.P |
| BT 02 | 805 |

* Ø 1-1/4 inch inlet & Ø 40 mm outlet

| PVC FLEXIBLE WASTE PIPE | |
|-------------------------|-------|
| CAT. MODEL | M.R.P |
| FP 01 | 250 |

* Ø 1-1/2 inch inlet & Ø 32 mm outlet



| PVC FLEXIBLE WASTE PIPE | |
|-------------------------|-------|
| CAT. MODEL | M.R.P |
| FP 02 | 255 |

* Ø 1-1/2 inch inlet / Ø 1-1/4 inch inlet & Ø 32 mm outlet

BATH ACCESSORIES



RACK BOLT

NEW



| CAT. MODEL | Product Description | Size (mm) | MRP (₹) |
|------------|-----------------------------|-----------|---------|
| JRB-01 | WC RACK BOLT WITH BRASS CAP | 16x165 | 645 |



| CAT. MODEL | Product Description | Size (mm) | MRP (₹) |
|------------|---------------------------|-----------|---------|
| JRB-02 | WC RACK BOLT WITH ABS CAP | 16x165 | 550 |



| CAT. MODEL | Product Description | Size (mm) | MRP (₹) |
|------------|---------------------|-----------|---------|
| JRB-03 | WC RACK BOLT L KEY | 12x160 | 745 |



| CAT. MODEL | Product Description | Size (mm) | MRP (₹) |
|------------|----------------------|-----------|---------|
| JRB-04 | WASH BASIN RACK BOLT | 10x115 | 160 |



| CAT. MODEL | Product Description | Size (mm) | MRP (₹) |
|------------|-----------------------|-----------|---------|
| JRB-05 | FLOOR MOUNTING KIT SS | 10x75 | 65 |



| CAT. MODEL | Product Description | Size (mm) | MRP (₹) |
|------------|---------------------|-----------|---------|
| JRB-06 | S.S. URINAL CLAMP | | 165 |

BOTTLE TRAP Chrome Finish (Brass)

NEW



| CAT. MODEL | Description | MRP (₹) |
|------------|--|---------|
| JBT-01 | Bottle Trap 32mm with Brass Pipe 175mm and 305mm | 1730 |



| CAT. MODEL | Description | MRP (₹) |
|------------|--|---------|
| JBT-02 | Bottle Trap 32mm with Brass Pipe 175mm and 305mm | 1790 |



| CAT. MODEL | Description | MRP (₹) |
|------------|--|---------|
| JBT-03 | Bottle Trap 32mm with Brass Pipe 175mm and 305mm | 1950 |

BOTTLE TRAP PIPE

NEW



| CAT. MODEL | Dimensions | Size | MRP (₹) |
|------------|------------|------|---------|
| BTP-01 | 30X225MM | 9" | 245 |



| CAT. MODEL | Dimensions | Size | MRP (₹) |
|------------|------------|------|---------|
| BTP-02 | 30X300MM | 12" | 325 |



| CAT. MODEL | Dimensions | Size | MRP (₹) |
|------------|------------|------|---------|
| BTP-03 | 30X450MM | 18" | 485 |

PTFE THREAD SEAL TAPE (TEFLON TAPE)

NEW



| CAT. MODEL | Dimensions Widh X Thickness X Length | COL. | MRP (₹) Per Pcs | QTY Per Box | QTY Per Cartoon |
|------------|---|--------|--------------------|----------------|--------------------|
| JTT-01 | 12mm x 0.10mm x 10mtr | Yellow | 34 | 10PCS | 250PCS |

BATH ACCESSORIES



Waste Coupling Pop-Up (Brass)



| CAT. Model | Description | Chrome | Black |
|------------|---|--------|-------|
| WPU 01 | 3" Full Brass Wash Basin Waste No Overflow with Pop-up, Full Thread | 1425 | 2075 |



| CAT. Model | Description | Chrome | Black | Gold | Rose Gold |
|------------|---|--------|-------|------|-----------|
| WPU 02 | 6" Full Brass Wash Basin Waste No Overflow with Pop-up, Full Thread | 2125 | 3040 | 3135 | 3135 |

Waste Coupling Ling Thread (Brass)

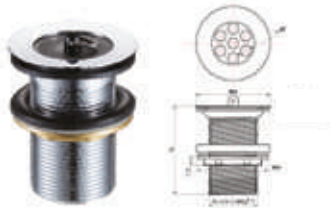

| CAT. Model | Description | Chrome |
|------------|--|--------|
| WLT 01 | 3" Basin Waste With 7 Holes And Brass Nut, Full Thread | 885 |



| CAT. Model | Description | Chrome |
|------------|--|--------|
| WLT 02 | 6" Basin Waste With 7 Holes And Brass Nut, Full Thread | 1425 |

Waste Coupling Dome Thread (Brass)

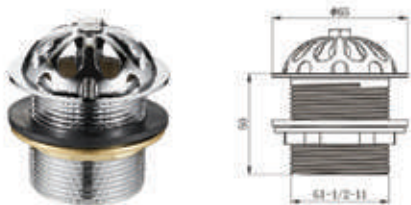

| CAT. Model | Description | Chrome |
|------------|------------------------------|--------|
| WDU 01 | Full Brass Male Urinal Waste | 1225 |

Finish





Shower Tube (Chrome)

Description: PVC inner lining with chromo look
Application: For health faucets & showers

| DIMENSIONS | | MRP (₹) |
|------------|-------------|---------|
| CAT. MODEL | Size (mtr.) | |
| JST 01 | 1.2 | 1,240 |



Stainless Steel Braided -Connector Pipe

Description: Epdm Stainless Steel 304 Baided Hose
Application: For Faucets

| DIMENSIONS | | MRP (₹) |
|------------|-----------|---------|
| CAT. MODEL | Size (mm) | |
| JCP 10 | 450 | 225 |
| JCP 11 | 600 | 270 |



Stainless Steel Braided -Connection Pipe

Description: Epdm Stainless Steel 304 Baided Hose
Application: For Geysers And Heaters, Nut Material-Brass

| DIMENSIONS | | MRP (₹) |
|------------|-----------|---------|
| CAT. MODEL | Size (mm) | |
| JCP 01 | 300 | 205 |
| JCP 02 | 450 | 230 |
| JCP 03 | 600 | 260 |
| JCP 04 | 750 | 380 |
| JCP 05 | 900 | 450 |



PVC -Connection Pipe With Brassnut

Description: Overall Diameter 15 mm
Application: For Geysers And Heaters

| DIMENSIONS | | MRP (₹) |
|------------|-----------|---------|
| CAT. MODEL | Size (mm) | |
| PCP 01 | 300 | 170 |
| PCP 02 | 450 | 185 |
| PCP 03 | 600 | 230 |
| PCP 04 | 750 | 280 |
| PCP 05 | 900 | 310 |

EXTENSION NIPPLES Chrome Finish (Brass)



| DIMENSIONS | | Quantity Per Box | MRP (₹) Per Piece |
|------------|-----------|------------------|-------------------|
| CAT. MODEL | Size (mm) | | |
| JEN 01 | 25 | 36 | 105 |
| JEN 02 | 40 | 24 | 155 |
| JEN 03 | 50 | 24 | 178 |
| JEN 04 | 63 | 24 | 220 |
| JEN 05 | 70 | 12 | 260 |
| JEN 06 | 100 | 12 | 355 |
| JEN 07 | 150 | 12 | 580 |



| CP HEX NIPPLE | | | |
|---------------|-----------|------------------|-------------------|
| CAT. MODEL | Size (mm) | Quantity Per Box | MRP (₹) Per Piece |
| JHN 01 | 41.50 | 20 | 175 |



| CP BUSH MALE | | |
|--------------|------------------|-------------------|
| CAT. MODEL | Quantity Per Box | MRP (₹) Per Piece |
| CBM 01 | 4 | 205 |

SIZE: Male threading 3/8 Female threading 15mm



| CP ELBOW | | | |
|------------|-----------|------------------|-------------------|
| CAT. MODEL | Size (mm) | Quantity Per Box | MRP (₹) Per Piece |
| CPE 01 | 39.5 | 4 | 365 |



| CP BUSH FEMALE | | |
|----------------|------------------|-------------------|
| CAT. MODEL | Quantity Per Box | MRP (₹) Per Piece |
| CBF 01 | 4 | 205 |

SIZE: Male threading 15mm Female threading 3/8



| CP TEE | | | |
|------------|-----------|------------------|-------------------|
| CAT. MODEL | Size (mm) | Quantity Per Box | MRP (₹) Per Piece |
| CPT 01 | 48.6 | 4 | 365 |

BATH ACCESSORIES



HEALTH FAUCETS



| DIMENSIONS | | MRP (₹) |
|-------------------------|-------------|---------|
| CAT. MODEL | Size (mtr.) | Glossy |
| HF 01 A (Brass & Ivory) | 1.5 | 1535 |



| DIMENSIONS | | MRP (₹) |
|-------------------------|-------------|---------|
| CAT. MODEL | Size (mtr.) | Glossy |
| HF 02 (Brass & Ivory) | 1 | 1,405 |
| HF 02 A (Brass & Ivory) | 1.5 | 1,535 |

JET SPRAY With CP tube (Stainless Steel)



| DIMENSIONS | | MRP (₹) |
|------------|-------------|---------|
| CAT. MODEL | Size (mtr.) | Matt |
| JS 03 | 1 | 750 |
| JS 03A | 1.5 | 790 |



| DIMENSIONS | | MRP (₹) |
|------------|-------------|---------|
| CAT. MODEL | Size (mtr.) | Matt |
| JS 04 | 1 | 750 |
| JS 04A | 1.5 | 790 |

FLANGES (Stainless Steel)



| DIMENSIONS | | MRP (₹) | |
|------------|------|---------|------|
| CAT. MODEL | Size | Glossy | Matt |
| F 01 | Ø 80 | 100 | 125 |



| DIMENSIONS | | MRP (₹) | |
|------------|------|---------|------|
| CAT. MODEL | Size | Glossy | Matt |
| F 02 | Ø 80 | 100 | 125 |



| DIMENSIONS | | MRP (₹) | |
|------------|------|---------|------|
| CAT. MODEL | Size | Glossy | Matt |
| F 03 | Ø 72 | 90 | 120 |



| DIMENSIONS | | MRP (₹) | |
|------------|------|---------|------|
| CAT. MODEL | Size | Glossy | Matt |
| F 04 | Ø 72 | 90 | 120 |



Scan to Download the
Catalogue

Jayna Gallery

Jayna Branch Office

Delhi

C-65, 1st Floor,
Sharda Puri, Opp.
Mansarovar Garden
Near Sant Nirankari
Satsang Bhawan,
Delhi-110015,

Phone:
011-45027843

Bengaluru

13-B, Ground
Floor, Gem Plaza,
Infantry Road,
Bengaluru-560 001,

Phone:
080-42017203

Mangalore

Ground Floor,
Samarpan Complex,
Opp: Pio Mall, Bejai
Church Road,
Mangalore - 575004.
Karnataka, India

Phone :
0824-4254707,
9141458822

Mumbai

15, Koteswar Palace,
Jiwa Mahale Marg,
Opp. Garware
Andheri(East),
Mumbai-400069,

Phone: 9310351299

Corporate Office:

Jain Brothers Sanitation Pvt. Ltd.

12-SSI, Industrial Estate, G.T. Karnal Road,
Delhi - 110033 India

Tel : +91 11 47020864/47087668

E-mail : info@jaynasinks.com

www.jaynasinks.com



The Kitchen Essentials

Note : This Price List is effective from 01.03.2023 & applicable all over India. All sizes are approximate. Company reserves the right to alter prices, models & specifications without any prior notice.